

**A**

**KITCHEN**  
COLLECTION

**ARMONY**

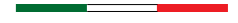

## Armony Cucine: Forty years of excellence.

Armony started out in the Treviso province in 1976. From a craft operation it soon became a successful industrial brand. The first idea was to create modern functional kitchens that blend in perfectly with home furnishings, enhancing them and providing the final touches.

**ARMONY**



Quarant'anni d'eccellenza.  
Armony esordisce nella provincia di Treviso nel 1976. Da attività artigianale diventa presto un marchio industriale di successo. L'idea è subito quella di realizzare cucine moderne e funzionali che si integrano perfettamente con l'arredo della casa, valorizzandolo e completandolo.

Quarante ans d'excellence.  
Armony a été fondée dans la province de Trévise en 1976. D'activité artisanale elle s'est rapidement transformée en une marque industrielle à la belle réussite. L'idée initiale a immédiatement été de créer des cuisines modernes et fonctionnelles, qui s'intègrent parfaitement avec le mobilier de la maison, en le valorisant et en le complétant.

## Versatility, production capacity and logistics at the service of small and large supplies.

Transforming the pleasure of functional spaces into tangible projects. Giving an additional security to quality: every item has been made to last. Interpreting contemporary lifestyles through formal research. So the designers at the Armony Research and Development Center bring technology and aesthetics together, to express the beauty of Italian kitchens in each and every design. Armony design center is an area of 1500 square metres where you can enjoy a personal view of what Armony has to offer and feel its in-depth quality, design and functionality. A large display area conceived as a meeting place to accommodate customers, distributors and agents.

In 2000, Armony added an important section dedicated to furniture for major projects to its historic production line of kitchens for the home. Furniture designed for public buildings and large businesses, hotels and large residences are all produced in our Mansuè plant, with the quality of the Armony Made in Italy style.

Versatilità, capacità produttiva e logistica al servizio delle piccole e grandi forniture.

Trasformare in progetto il piacere di spazi funzionali e della socialità domestica. Dare alla qualità una sicurezza in più, quella che ogni elemento è stato pensato per durare. Interpretare con la ricerca formale gli stili di vita contemporanei. Così i designer del Centro Ricerca e Sviluppo Armony uniscono tecnica ed estetica, per esprimere in ogni modello la bellezza della cucina italiana. Armony Design Center è uno spazio di 1500 mq per conoscere da vicino le proposte Armony e approfondire la qualità, il design, la funzionalità. Un grande spazio espositivo pensato come luogo d'incontro per accogliere clienti, distributori e agenti.

Nel 2000, Armony aggiunge alla storica linea di produzione di cucine per la casa un'importante sezione dedicata ai mobili per i grandi progetti. Nello stabilimento di Mansuè nascono mobili progettati per le architetture pubbliche e commerciali, gli hotel e le grandi residenze, con la qualità del Made in Italy Armony.

Polyvalence, capacité de production et logistique au service des petites et grandes fournitures.

Transformer en projet le plaisir d'avoir des espaces fonctionnels et un lieu social au sein de la maison. Donner à la qualité une sécurité supplémentaire : chaque élément est conçu pour durer. Interpréter par la recherche des formes les modes de vie contemporains. Ainsi, les designers du Centre de recherche et de développement Armony allient technique et esthétique, pour exprimer la beauté dans chaque modèle de la cuisine italienne. Armony design center est un espace de 1500 mètres carrés permet de découvrir les propositions Armony et d'approfondir la qualité, le design, la fonctionnalité. Ce grand espace d'exposition est conçu comme un lieu de réunion pour accueillir les clients, les distributeurs et les agents.

En 2000, Armony a ajouté à la ligne de production historique des cuisines pour la maison une importante section dédiée aux meubles pour les grands projets. Ces meubles, conçus pour les bâtiments publics et commerciaux, les hôtels et les grandes résidences, sont fabriqués dans l'établissement de Mansuè, avec la qualité du Made in Italy Armony.





## High-tech professionalism and efficiency.

Professionalità ed efficienza ad alta tecnologia. Guidare l'evoluzione del gusto, ma anche quella della tecnologia. Le cucine Armony sono prodotte in uno stabilimento all'avanguardia, dove gli sprechi sono ridotti al minimo e la precisione è massima, e dove l'abilità dell'uomo fa sempre la differenza.

Driving the evolution of taste, but also of technology. Armony kitchens are produced in an avant-garde facility, where waste is minimized and precision is maximized, and where the ability of man always makes a difference.

Professionnalité et efficacité à haute technologie. Guider l'évolution du goût, mais aussi celle de la technologie. Les cuisines Armony sont fabriquées dans une usine à l'avant-garde, où les gaspillages sont réduits au minimum et la précision est maximale, et où l'habileté de l'homme fait toujours la différence.



008	<b>Yota</b>	COMPOSITION <b>01   02   03   04</b>
042	<b>Omicron 22</b>	COMPOSITION <b>01   02   03   04</b>
074	<b>T16</b>	COMPOSITION <b>01   02   03</b>
096	<b>Rho</b>	COMPOSITION <b>01   02   03   04   05   06</b>
140	<b>Tau</b>	COMPOSITION <b>01   02   03</b>
160	<b>Ypsilon</b>	COMPOSITION <b>01   02   03   04   05</b>
186	<b>Kappa</b>	COMPOSITION <b>01   02   03</b>
204	<b>Pentha</b>	COMPOSITION <b>01   02</b>
218	<b>Diadema</b>	COMPOSITION <b>01</b>
226	<b>Quadratika</b>	COMPOSITION <b>01</b>
232	<b>Summary</b>	
242	<b>Finishings</b>	
<hr/>		
254	<b>Kitchen Details</b>	
262	<b>Opening Typologies</b>	
267	<b>Accessories</b>	
273	<b>Internal Accessories</b>	



# YOTA

Outstanding 22 mm thick doors make an important statement in the kitchen, together with the materials employed, such as the wide range of skilfully worked wood veneers, glossy, matt and Vintage lacquered. The variety of compositions reflects the many different ways of using a kitchen. Doors can be customised with refined handles, such as Zeta or Lambda, so that the kitchen is in tune with the personalities of those who use it.

Ricca anta dallo spessore 22 millimetri che conferisce particolare importanza alla cucina e ai materiali in essa usati, come la vasta scelta di legni impiallacciati finemente lavorati e i laccati lucidi, opachi e Vintage. La grande varietà compositiva soddisfa i più svariati modi di vivere la cucina e la personalizzazione delle ante con metodi di apertura dal design ricercato - come la maniglia Zeta o Lambda - permettono di caratterizzare l'ambiente cucina secondo la personalità di ciascuno.

Riche porte d'une épaisseur de 22 millimètres qui confère une importance particulière à la cuisine et aux matériaux qui y sont utilisés, comme le large choix de bois plaqués finement travaillés et les laqués brillants, mats et Vintage. La grande variété de composition satisfait les modes les plus variés de vivre la cuisine et la personnalisation des portes avec des méthodes d'ouverture au design recherché - comme la poignée Zeta ou Lambda - permettent de caractériser l'ambiance cuisine selon la personnalité de chacun.

COMPOSITION **01 | 02 | 03 | 04**

#### Openings / Aperture / Ouvertures



#### Thickness / Spessore / Epaisseur



#### Finishings / Finiture / Finitions

Flamed / knotted / serrated oak    Rovere fiammato / nodato / seghettato    Chêne flammé / avec noeuds / tranché

Matt/glossy lacquered    Laccato opaco/lucido    Laqué mat/brillant

Glossy metallic lacquered    Laccato metallizzato    Laqué métallisé brillant

Vintage lacquered    Laccato Vintage    Laqué Vintage













Yota

COMPOSITION **01**



A modern, minimalist kitchen with tall units and an island in Neve matt lacquered enlivened by inserts and open units in Oliva flamed oak. The functional nature of the composition is underlined by the Sigma lacquered grip profile that makes full use of the practical internal space. The Hi-Macs acrylic top integrates with the island to form a convenient table with stools.

Una cucina moderna e minimalista con colonne e isola in laccato opaco Neve, scaldata da inserti e vani a giorno in rovere fiammato Oliva. La composizione è resa funzionale dalla gola Sigma laccata che permette di usufruire degli ampi spazi interni con praticità. Il top in acrilico Hi-Macs integra all'isola un comodo tavolo per gli sgabelli.

Une cuisine moderne et minimaliste avec des colonnes et un îlot en laqué mat Neve, réchauffée par des inserts et des compartiments ouverts en chêne rouvre flammé Oliva. La composition est rendue fonctionnelle par le profil gorge Sigma laqué qui permet d'utiliser de larges espaces internes de façon pratique. Le top en acrylique Hi-Macs intègre à l'îlot une table pratique pour les tabourets.









This composition links a living room that repeats the wood veneer hues of the kitchen, enlivened by matt lacquered Corda. In this way Armony confirms its trend towards a global home décor project.

La composizione unisce un'area living che riprende le tonalità del legno impiallacciato della cucina, scaldato dal laccato opaco Corda. Segno che Armony si affaccia sempre più ad un progetto globale del vivere la casa.

La composition unit une zone living qui reprend les tonalités du bois plaqué de la cuisine, réchauffé par le laqué mat Corda. Signe qu'Armony se présente de plus en plus comme un projet global de l'art de vivre la maison.









**Yota**

COMPOSITION **02**

The stainless steel finish Zeta handle, recessed into the entire length of the door, gives to the composition a refined, modern look. This kitchen décor pleasantly combines different materials – from the new matt lacquered Titanio and Moka to the Unicolor Botticino top with integrated sink, to the Vintage wood Trento for the snack counter.

La maniglia Zeta, in finitura inox, incassata sull'anta per tutta la lunghezza dona a questa composizione un carattere moderno e ricercato. Cucina che combina con armonia diversi materiali - dal nuovo laccato opaco Titanio e Moka, al top in Unicolor Botticino con vasca integrata, al legno Vintage Trento per il piano snack.

La poignée Zeta, en finition inox, encastrée sur la porte pour toute la longueur donne à cette composition un caractère moderne et recherché. Une cuisine qui combine avec harmonie différents matériaux – du nouveau laqué mat Titanio et Moka, au plan en Unicolor Botticino avec une vasque intégrée, au bois Vintage Trento pour le plan snack.









The new glass doors in fumé finish, an exclusive design for Armony cucine, feature a black anodised aluminium frame that integrates the handle for the full height of the door.

Le nuove vetrine in vetro fumé, disegnate in esclusiva per Armony cucine, sono caratterizzate da un telaio in alluminio anodizzato nero che integra la maniglia in tutta la sua altezza.

Les nouvelles vitrines en verre fumé, dessinées en exclusivité pour Armony cuisines, sont caractérisées par un châssis en aluminium anodisé Noir qui intègre la poignée dans toute sa hauteur.











Neve glossy lacquered kitchen units with a contemporary air provided by the personality of the integrated Lambda handle and the warm colour of the Dekton Aura 15 work top. The Quercia antique wood snack counter increases the working area by forming a convenient table that follows the shape of the peninsula.

Cucina in laccato lucido Neve, resa contemporanea dal carattere deciso della maniglia integrata Lambda e dal calore del Dekton Aura 15 come piano di lavoro. Lo snack in legno antico Quercia in appoggio aumenta l'area operativa formando un comodo tavolo che segue la forma della penisola.

Une cuisine en laqué brillant Neve, rendue contemporaine par le caractère franc de la poignée intégrée Lambda et par la chaleur du Dekton Aura 15 comme plan de travail. Le snack en bois ancien Quercia posé, augmente la zone opérationnelle en formant une table pratique qui suit la forme de la péninsule.



Yota

COMPOSITION **03**





The finish on the tall units is the exclusive Vintage Iron lacquered, finished by hand to achieve a unique effect and give to the kitchen an original touch.

Le colonne sono realizzate nell'esclusiva laccatura Vintage Iron che viene rifinita a mano per ottenere un effetto unico e per donare alla cucina un tocco di originalità.

Les colonnes sont réalisées dans le laquage exclusif Vintage Iron qui est fini à la main pour obtenir un effet unique et pour donner à la cuisine une touche d'originalité.









Yota

COMPOSITION **04**



A full, linear composition featuring the modern black handle Last. The deep base units provide an extended working area on the worktop Fenix NTM® Nero. The storage wall and integrated table complete the effect of different volumes in the tall units in Gianduia knotted oak, base units in Neve matt lacquered and Nero lacquered wall units. Above, the internal Intivo Inox drawers with Easy Line modular accessories in Canaletto Walnut.

Una composizione lineare e completa, caratterizzata dalla moderna maniglia Last nera. Le basi profonde offrono una maggiore area di lavoro sul top in Fenix NTM® Nero. La parete attrezzata e il tavolo integrato completano il gioco di volumi tra colonne, in rovere nodato Gianduia, basi in laccato opaco Neve e pensili in laccato Nero. In alto i cassetti interni Intivo Inox con accessori modulari Easy Line in Noce Canaletto.

Une composition linéaire et complète caractérisée par la poignée moderne Last noire. Les éléments bas profonds offrent une zone de travail plus importante sur le top Fenix NTM® Nero. La cloison équipée et la table intégrée complètent le jeu de volumes entre les colonnes, en chêne rouvre avec nœuds Gianduia, les éléments bas en laqué mat Neve et les éléments hauts laqués Nero. En haut, les cassettes internes Intivo Inox avec des accessoires modulars Easy Line en Noyer Canaletto.







Above, the under wall unit accessories Modus. Entirely in black anodised aluminium, they form a storage wall that provides the kitchen with useful extra space. On the right the new T44L structure for height adjustable tables and work tops.

In alto gli accessori sottopensile della linea Modus. Interamente realizzati in alluminio anodizzato nero, formano una parete attrezzata che aumenta lo spazio utile della cucina. A destra la nuova struttura T44L per tavolo e bancone regolabile in altezza.

En haut les accessoires sous-éléments hauts de la ligne Modus. Entièrement réalisés en aluminium anodisé noir, forment une cloison équipée qui augmente l'espace utile de la cuisine. À droit, la nouvelle structure T44L pour table et comptoir réglable en hauteur.









# OMICRON 22

An innovative model proposing modern coordination of straight lines, unusual materials and evocative configurations; solutions featuring special attention to details found in the profile of the 22mm thick door with its 33° shaping, never forgoing functionality. This kitchen furniture provides new rhythm to daily life and fulfils the user's wish for customisation.

Un modello innovativo che propone abbinamenti moderni tra linee rette, materiali inediti e suggestive configurazioni dell'ambiente; soluzioni caratterizzate da una particolare attenzione ai dettagli che si raccontano nel profilo dell'anta spessore 22 mm sagomato a 33° e che non dimenticano mai la dimensione funzionale e la quotidianità. Una cucina che riesce ad assecondare nuovi ritmi di vita quotidiana e a soddisfare desideri di personalizzazione.

Un modèle innovant qui propose des assemblages modernes entre les lignes droites, des matériaux inédits et des configurations suggestives de l'ambiance; des solutions caractérisées par une attention particulière aux détails qui se racontent dans le profil de la porte épaisseur 22 mm façonné à 33° et qui n'oublie jamais la dimension fonctionnelle et quotidienne. Une cuisine qui parvient à accompagner les nouveaux rythmes de vie quotidienne et à satisfaire des désirs de personnalisation.

COMPOSITION **01 | 02 | 03 | 04**

## Openings / Aperture / Ouvertures



## Thickness / Spessore / Epaisseur



## Finishings / Finiture / Finitions

Flamed / knotted / serrated oak    Rovere fiammato / nodato / seghettato    Chêne flammé / avec noeuds / tranché

Matt/glossy laquered    Laccato opaco/lucido    Laqué mat/brillant

Glossy metallic laquered    Laccato metallizzato    Laqué métallisé brillant

Vintage laquered    Laccato Vintage    Laqué Vintage

Melamine, walnut finish    Melaminico, finitura Noce    Mélaminé, finition noyer

Thermostructured melamine, sablé finish    Melaminico termostrutturato, finitura sablé    Mélaminé termostructuré, finition sablé

Thermostructured melamine, Eucalyptus finish    Melaminico termostrutturato, finitura Eucalipto    Mélaminé termostructuré, finition eucalyptus

Horizontal knotted, thermostructured melamine    Melaminico termostrutturato, nodato orizzontale    Mélaminé termostructuré, horizontal avec noeuds

Thermostructured melamine, concrete finish    Melaminico termostrutturato, finitura cemento    Mélaminé termostructuré, finition béton

Matt melamine, skin finish    Melaminico opaco, finitura skin    Mélaminé mat, finition skin

Concrete    Resina Cemento    Résine cimentée







Omicron 22

COMPOSITION **01**



Kitchen decor featuring an important Grigio Fumo glossy lacquered island with 12mm thick side panels and a large work top in Laminam Antracite with welded sink. The Omicron doors with their 33° profile, combined with a flat glossy lacquered grip profile, form straight lines that outline the main feature of the island. The counter is in reclaimed antique wood with Abete nero finish.

Cucina caratterizzata da un'importante isola laccata lucida Grigio Fumo, con fianchi spessore 12 mm e ampio piano di lavoro in Laminam Antracite con vasca saldata. Le ante Omicron con profilo a 33° combinate alla gola piatta laccata lucida, formano linee rette che disegnano l'isola, protagonista dell'ambiente che la circonda. Il bancone è realizzato con legno proveniente da recuperi di antica edilizia, in finitura Abete nero.

Une cuisine caractérisée par un îlot important laqué brillant Grigio Fumo, avec des joues d'une épaisseur de 12 mm et une vaste zone de travail en Laminam Antracite avec vasque soudée. Les portes Omicron avec un profil à 33° combinées au profil gorge plat laqué brillant, forment des lignes droites qui dessinent l'îlot, protagoniste de l'ambiance qui l'entoure. Le comptoir est réalisé avec du bois provenant de récupérations de bâtiments anciens, en finition Abete nero.





The tall units integrate the Wing system with recessed doors. This is an exclusive element that makes it possible to store equipment inside the tall units and create more working space in the kitchen.

Le colonne integrano il sistema Wing con ante rientranti. Elemento esclusivo che permette di racchiudere all'interno degli armadi attrezzature che aumentano ulteriormente lo spazio di lavoro.

Les colonnes intègrent le système Wing avec des portes rentrantes. Un élément exclusif qui permet de renfermer à l'intérieur des armoires, des équipements qui en augmentent l'espace de travail.











Omicron 22

COMPOSITION **02**



Kitchen furniture with refined, warm finishes thanks to the new matt lacquered finish Grigio metro, Oliva flamed oak and tops in Laminam Emperador grigio spazzolato. Above, Modus under wall unit accessories in black anodised aluminium.

Cucina dalle finiture calde e raffinate grazie al nuovo laccato opaco Grigio metro, al rovere fiammato Oliva e al top in Laminam Emperador grigio spazzolato. Sopra, accessori sottopensile Modus in alluminio anodizzato nero.

Une cuisine aux finitions raffinées et chaudes grâce au nouveau laqué mat Grigio Metro, au chêne rouvre flammé Oliva et au top en Laminam Emperador gris brossé. Au-dessus, les accessoires sous-élément haut Modus en aluminium anodisé noir.











Elite Line modular accessories that make maximum use of the space inside the deep drawers. In walnut solid wood and stainless steel.

In alto e a destra, accessori modulari Elite Line che permettono di sfruttare al massimo lo spazio interno dei cestoni. Realizzati in massello di noce e inox.

En haut et à droite, les accessoires modulaires Elite Line qui permettent d'exploiter au maximum l'espace interne des casseroles. Réalisés en bois massif Noyer et Inox.





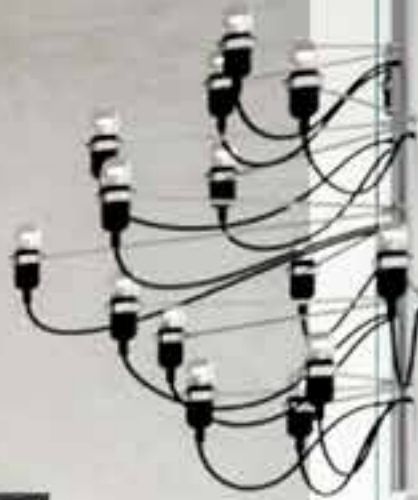







## Omicron 22 | COMPOSITION **03**

A linear composition that reflects the modern, minimal look of the Omicron 22 model. The uncluttered lines of the door, the flat grip profile and H.6cm plinth, together with 87cm high base units, make this kitchen furniture functional and capacious.

Composizione lineare che rispecchia il carattere moderno e minimale del modello Omicron 22. Le linee pulite dell'anta, la gola piatta e lo zoccolo h6 cm, combinati con le basi alte 87 cm, rendono questa cucina funzionale, grazie all'elevato spazio contenitivo.

Une composition linéaire qui reflète le caractère moderne et minimaliste du modèle Omicron 22. Les lignes sobres de la porte, le profil gorge plat et le socle h6 cm, combinés avec les éléments bas d'une hauteur de 87 cm, rendent cette cuisine fonctionnelle, grâce à l'espace de rangement important.





The 5mm Inox Wirbel Steel top forms a snack counter that links the living room and kitchen. Above, a detail of the tall storage unit with Kesseböhmer Convoi mechanism, that pulls out to take full advantage of the depth.

Il top in Inox Wirbel Steel da 5 mm pieno forma un piano snack che fonde il living con la cucina. Sopra, un dettaglio della colonna attrezzata con meccanismo Kesseböhmer Convoi, completamente estraibile per sfruttare la dispensa in tutta profondità.

Le plan en Inox Wirbel Steel de 5 mm plein forme un plan snack qui fond le living avec la cuisine. Au-dessus, un détail de la colonne équipée avec un mécanisme Kesseböhmer Convoi, complètement amovible pour exploiter le garde-manger dans toute sa profondeur.









Kitchen furniture featuring different symmetries and volumes, combining knotted oak Caffè with the splendid Dark grey concrete finish for doors, grip profiles and plinths.

Cucina caratterizzata da un gioco di simmetrie e volumi che combina il rovere nodato Caffè con la ricca finitura cemento Dark grey sia per le ante che per gole e zoccoli.

Une cuisine caractérisée par un jeu de symétries et de volumes qui combine le chêne rouvre avec nœuds Caffè avec la riche finition Dark grey aussi bien pour les portes que pour les profils gorge et socles.





An Omicron kitchen boasts uncluttered, essential lines that integrate perfectly with the architecture of the house, enhancing and completing it. The approach aims at design featuring constant research into aesthetics and technology.

Una cucina Omicron dalle linee pulite ed essenziali che si integra perfettamente con l'architettura casa, valorizzandola e completandola. Un approccio al progetto da sempre improntato sul design, testimoniato dalla costante ricerca estetica e tecnologica.

Une cuisine Omicron aux lignes sobres et essentielles qui s'intègre parfaitement à l'architecture maison, en la valorisant et la complétant. Une approche au projet depuis toujours basée sur le design, témoignée par la recherche constante esthétique et la technologie.

Above, a living room composition with suspended base units, wall units and new Size accessories in black anodised tubular aluminium.

A destra una composizione living con basi sospese, pensili e i nuovi accessori Size in tubolare di alluminio anodizzato nero.

En haut, une composition living avec des éléments bas suspendus, des éléments hauts et les nouveaux accessoires Size en tube d'aluminium anodisé noir.







# T 16

The elegant reflections of glass and the expressive texture of Laminam, also available for the work top. T16 interprets modernity with an original, elaborate door that unites several materials in a single piece and provides a refined choice of fronts: glossy or matt toughened glass in a choice of six different colours and porcelain stoneware in six texture variants. The rounded grip profile in the same aluminium finish as the framed door enhances its modern nature.

Gli eleganti riflessi del vetro e le espressive texture del Laminam, disponibili anche per il piano di lavoro. T16 interpreta la modernità con un'anta originale ed elaborata che combina in un unico corpo diversi materiali e offre raffinate scelte di rivestimento frontale: il vetro temperato lucido e opaco, da scegliere tra sei diversi colori, e il Gres in altre sei varianti materiche. L'apertura con gola arrotondata nella stessa finitura alluminio del telaio dell'anta valorizza il suo carattere moderno.

Les reflets élégants du verre et les textures expressives du Laminam, également disponibles pour le plan de travail. T16 interprète la modernité avec une porte originale et élaborée qui combine en un seul corps différents matériaux et offre des choix raffinés de revêtement façade : le verre trempé brillant et mat, à choisir entre six couleurs différentes, et le Gres dans six autres variantes matériques. L'ouverture avec profil gorge arrondi dans la même finition aluminium que le châssis valorise son caractère moderne.

COMPOSITION **01 | 02 | 03**

## Openings / Aperture / Ouvertures



## Thickness / Spessore / Epaisseur



## Finishings / Finiture / Finitions

Matt tempered glass   Vetro temperato opaco   Verre trempé mat

Glossy tempered glass   Vetro temperato lucido   Verre trempé brillant

Gres







**T16** | COMPOSITION **01**

A composition that mixes the elegance of Bianco moon brushed glass for the base units with the warm Terra Laminam of the tall units. Everything combines to create the strong character of the grained work top in matt Laminam Bianco statuario. Such combinations are possible due to the refined styling of the door, the aluminium frame of which can be completed with different fronts.

Una composizione che mescola l'eleganza del vetro satinato Bianco moon delle basi al calore del Laminam Terra delle colonne. Tutto combinato al carattere deciso del piano di lavoro venato in Laminam Bianco statuario opaco. Combinazioni possibili grazie al ricercato design dell'anta che tramite un telaio di alluminio può ospitare diversi rivestimenti frontali.

Une composition qui mélange l'élégance du verre satiné Blanc moon des éléments bas à la chaleur du Laminam Terra des colonnes. Le tout combiné au caractère franc du plan de travail veiné en Laminam Bianco statuaire mat. Des combinaisons possibles grâce au design recherché de la porte qui grâce à un châssis en aluminium peut accueillir différents revêtements de façades.











T16

COMPOSITION 02



Kitchen units with doors faced with matt Titan toughened glass and Laminam Antracite. This is also used for the entire island and sink bowl with steel support, to make a statement in your home.  
On the right, a tall unit with Kessebohmer pull-out mechanism, provided with height adjustable baskets

Cucina con ante rivestite in vetro temperato opaco Titan e Laminam Antracite. Quest'ultimo viene usato per rivestire l'intera isola e la vasca del lavello con supporto in acciaio, per diventare protagonista all'interno della casa.  
A destra, colonna con meccanismo Kessebohmer estraibile dotata di cestelli regolabili in altezza.

Une cuisine avec des portes revêtues en verre trempé mat Titan et Laminam Antracite. Ce dernier est utilisé pour revêtir tout l'îlot et la vasque de l'évier avec support en acier, pour devenir protagoniste à l'intérieur de la maison.  
À droite, une colonne avec un mécanisme Kessebohmer amovible, dotée de paniers réglables en hauteur.











Above, the new Size open wall units in Nero grafite anodised aluminium, here combined with wall units to create a unique look.

Sopra, i nuovi pensili a giorno Size in alluminio anodizzato Nero grafite, proposti in combinazione con i pensili per un risultato unico.

En haut, les nouveaux éléments hauts ouverts Size en aluminium anodisé Nero grafite, proposés en combinaison avec les éléments hauts pour un résultat unique.









**T16**

COMPOSITION **03**

A composition designed around a square island. Faced entirely in Grafite glossy glass, softened by Limo flamed oak and a work top in Lapitec Nero, an extraordinary material ideal for use in the kitchen: scratchproof, UV resistant and unaffected by solvents.

Una composizione disegnata attorno all'isola quadrata che diventa protagonista. Interamente rivestita in vetro lucido Grafite, viene scaldata dal rovere fiammato Limo e dal piano di lavoro in Lapitec Nero, materiale dalle straordinarie caratteristiche adatte all'utilizzo nell'ambiente cucina, antigraffio e inalterabile ai raggi UV e ai solventi.

Une composition dessinée autour de l'îlot carré qui devient protagoniste. Entièrement revêtue en verre brillant Grafite, elle est réchauffée par le chêne rouvre flammé Limo et par le plan de travail en Lapitec Nero, matériau aux caractéristiques extraordinaires adaptées à l'utilisation dans l'ambiance cuisine, anti-rayures et inaltérable au contact des rayons UV et des solvants.





These pages show a detail of the Nomad internal accessories in black ashwood solid wood. The wide range of modules allows free customisation of drawers and deep drawers.

In queste pagine, un dettaglio degli accessori interni Nomad in massello di frassino nero, che grazie alla vasta modularità permette un'elevata personalizzazione di cassetti e cestoni interni.

Dans ces pages, un détail des accessoires internes Nomad en bois massif de frêne noir, qui grâce à la vaste modularité permet une personnalisation élevée de tiroirs et casseroles internes.





# RHO

This model with 22mm thick doors introduces innovative materials ideal for use in the kitchen, such as termostrutturato melamine and Italian made Maxximatt/Maxxigloss panted surface. Modern alternatives to wood veneer or lacquered finishes allow everyone to enjoy a refined, contemporary kitchen that does not forgo quality and strength.

Modello con anta spessore 22 mm che introduce materiali innovativi adatti all'uso nell'ambiente cucina come il melaminico termostrutturato e il Maxximatt/Maxxigloss verniciato lucido e opaco di produzione italiana. Alternative moderne al legno impiallacciato o al laccato per permettere a tutti di avere una cucina raffinata e contemporanea senza tralasciare la qualità e la resistenza all'usura.

Modèle avec porte d'une épaisseur de 22 mm qui introduit des matériaux innovants adaptés à l'utilisation dans l'ambiance cuisine comme le mélaminé termostructuré et le Maxximatt/Maxxigloss verni brillant et mat de production italienne. Une alternative moderne au bois plaqué ou au laqué pour permettre à tous d'avoir une cuisine raffinée et contemporaine sans négliger la qualité et la résistance à l'usure.

COMPOSITION **01 | 02 | 03 | 04 | 05 | 06**

## Openings / Aperture / Ouvertures



## Thickness / Spessore / Epaisseur



## Finishings / Finiture / Finitions

Maxximatt®

Maxxigloss®

Melamine, walnut finish   Melaminico, finitura Noce   Mélaminé, finition noyer

Thermostructured melamine, sablé finish   Melaminico termostrutturato, finitura sablé   Mélaminé termostructuré, finition sablé

Thermostructured melamine, Eucalyptus finish   Melaminico termostrutturato, finitura Eucalpto   Mélaminé termostructuré, finition eucalyptus

Horizontal knotted, thermostructured melamine   Melaminico termostrutturato, nodato orizzontale   Mélaminé termostructuré, horizontal avec noeuds

Thermostructured melamine, concrete finish   Melaminico termostrutturato, finitura cemento   Mélaminé termostructuré, finition béton

Matt melamine, skin finish   Melaminico opaco, finitura skin   Mélaminé mat, finition skin













Rho | COMPOSITION **01**



This composition shows the new height adjustable structure for peninsulas, available in two colour variants, and the Modular storage wall that gives the kitchen a unique look. This accessory with its Titanium finish increases the functionality of the work top and comes with a choice of inserts.

Composizione che mostra la nuova struttura per penisola regolabile in altezza, disponibile in due varianti colore, e la parete attrezzata Modular che conferisce alla cucina un aspetto unico. Questo accessorio, in finitura Titanio, permette di aumentare la funzionalità del piano di lavoro ed è dotato di svariati inserti tra cui scegliere.

Composition qui montre la nouvelle structure pour péninsule réglable en hauteur, disponible dans deux variantes de couleurs, et la cloison équipée Modular qui confère à la cuisine un aspect unique. Cet accessoire, en finition titane, permet d'augmenter la fonctionnalité du plan de travail et est doté de différents inserts au choix.





The new thermostructured melamine in Eucalyptus finish places this contemporary composition in line with the most modern trends and is available in several colour variants. Above, a detail of the aluminium profile for internal shelves.

Il nuovo melaminico termostrutturato Eucalpto rende questa composizione contemporanea e al passo con le tendenze più moderne, disponibile in due diverse varianti colore. Sopra un dettaglio che mostra il profilo in alluminio per ripiani interni.

Le nouveau stratifié thermostructuré Eucalpto rend cette composition contemporaine et conforme aux tendances les plus modernes, disponible dans deux variantes de couleurs différentes. Ci-dessus, un détail qui montre le profil en aluminium pour étagères internes.



Modern kitchen units that combine different finishes to create a stunning visual effect. From the matt Cachemire melamine Skin finish to the new thermostructured melamine Eucalipto grigio, and the top in Dekton Galema finish.

Una cucina dal carattere moderno che combina diverse finiture dal forte impatto visivo. Dal melaminico opaco Cachemire finitura Skin al nuovo melaminico termostrutturato Eucalipto grigio, fino al top in Dekton finitura Galema.

Une cuisine au caractère moderne qui combine différentes finitions à l'impact visuel fort. Du mélaminé mat Cachemire finition Skin au nouveau mélaminé thermostructuré Eucalipto grigio, jusqu'au top en Dekton finition Galema.











Rho

COMPOSITION **02**



Kitchen units faced entirely in thermostructured melamine Moon and Nodato Fumo.  
Above the new interior glass shelves with aluminum profiles.

Cucina interamente rivestita in melaminico termostrutturato Moon e Nodato Fumo.  
Sopra i nuovi ripiani interni in vetro con profilo in alluminio.

Cuisine entièrement revêtue en mélaminé thermostructuré Moon et Nodato Fumo.  
Au-dessus des nouvelles étagères en verre intérieur avec des profilés en aluminium.





The Boiserie proposed by Armony is made up of a modular aluminium structure to take panels. It comes with shelving, available in fumé glass. On side the Moon concrete finish creates an awesome 3D surface with exciting contrasts.

La Boiserie che Armony propone è realizzata tramite una struttura modulare di alluminio pannellabile. E' dotata di ripiani disponibili in vetro fumé. A lato la finitura cemento Moon stupisce per la sua superficie 3D ricca di contrasti.

La Boiserie qu'Armony propose est réalisée au moyen d'une structure modulaire d'aluminium habillable. Elle est dotée d'étagères disponibles également en verre fumé. Ci-contre, la finition Moon étonne par la superficie 3D riche en contrastes.







The Absolute Blanc quartz top is an affordable, effective solution that gives the kitchen a unique look thanks to the the fantastic shading and attractive luminosity it creates. It comes with pull-out multiple electric sockets.

Il top in quarzo Absolute Blanc è una soluzione efficace e poco dispendiosa per dare tutto un altro aspetto alla cucina, grazie alle ipnotiche sfumature e alla seducente luminosità trasmessa. E' dotato di presa elettrica multipla estraibile.

Le plan en quartz Absolute Blanc est une solution efficace et peu onéreuse pour donner un tout autre aspect à la cuisine, grâce aux nuances hypnotiques et à la luminosité séduisante transmise. Il est doté de prise électrique multiple amovible.









Rho

COMPOSITION **03**



Kitchen units in thermostructured Sablé Grigio melamine and Nuvola matt melamine, with integrated table which is a continuation of the work top that provides a neat, uncluttered look.

Cucina in melaminico termostrutturato Sablé Grigio e melaminico opaco Nuvola, con tavolo integrato che risulta essere la continuazione del piano di lavoro per una pulizia estetica massima.

Une cuisine en mélaminé thermostructuré Sablé Grigio et mélaminé mat Nuvola, avec table intégrée qui s'avère être la continuité du plan de travail pour une sobriété esthétique maximum.



On the top, open wall units with folded 45° inclined edges, available with a glossy, matt or metalised lacquered finish.

Sopra, i pensili a giorno con bordo inclinato a 45° realizzati in folding, disponibili in laccato lucido, opaco e metallizzato.

Au-dessus, les éléments hauts ouverts avec chant incliné à 45° réalisés en folding, disponibles en laqué brillant, mat et métallisé.









Rho

COMPOSITION **04**



Kitchen units with integrated table in Maxxigloss, a PVC-free, self-coloured painted laminate, a modern alternative to lacquered kitchen furniture. This product is made in Italy and provides great UV resistance, is scratch proof and unaffected by chemicals.

Cucina con tavolo integrato interamente realizzata in Maxxigloss, una lamina PVC-free colorata in massa e poi verniciata, alternativa moderna alla cucina laccata. È prodotto in Italia e offre la massima resistenza ai raggi UV, alta resistenza al graffio e all'azione dei prodotti chimici.

Cuisine avec table intégrée entièrement réalisée en Maxxigloss, une plaque PVC-free colorée en masse et ensuite vernie, alternative moderne à la cuisine laquée. Elle est produite en Italie et offre une résistance maximum aux rayons UV, une résistance élevée aux rayures et à l'action des produits chimiques.







A compact, functional living room composition that incorporates an up and over mechanism that facilitates use of low units.

Una composizione living compatta e funzionale, grazie anche al meccanismo a ribalta che permette di usufruire comodamente anche dei mobili bassi.

Une composition living compacte et fonctionnelle, grâce également au mécanisme à abattant qui permet aussi de profiter aisément des meubles bas.









**Rho** | COMPOSITION **05**

Kitchen units with 22mm thick doors in Maximatt® Latte and a top in Fenix Alaska, bigger than the island to create a convenient snack counter. The tall units and wall units are in the new melamine thermostructured Noce Canaletto. The grip profile and plinths are in aluminium.

Cucina con ante spessore 22 mm in Maximatt® Latte con top in Fenix Alaska che ha una dimensione maggiore rispetto all'isola per creare una comoda area snack. Le colonne e i pensili presentano il nuovo melaminico termostrutturato Noce canaletto. La gola e gli zoccoli sono in Alluminio.

Cuisine avec porte de 22 mm d'épaisseur en Maximatt® Latte avec plan en Fenix Alaska qui a une dimension plus importante par rapport à l'îlot pour créer une zone snack pratique. Les colonnes et les éléments hauts présentent le nouveau mélaminé thermostructuré Noce canaletto. Le profil gorge et les socles sont en Aluminium.









**Rho** | COMPOSITION **06**

This solution has H.6cm plinths and flat grip profile with Inox finish, H.87cm base units with Zeta encased handle and H.144cm tall units. The material is matt melamine Grigio scuro and Nuvola, with top in hpl Nero Climb laminate.

Soluzione dai volumi moderni con zoccolo h 6 cm e gola piatta in finitura Inox, basi h 87 cm con maniglia incassata Zeta e colonne h 144 cm. In melaminico opaco Grigio scuro e Nuvola, con top in laminato hpl Nero Climb.

Solution aux volumes modernes avec un socle de h 6 cm et profil gorge plat en finition Inox, éléments bas h 87 cm avec poignée encastrée Zeta et colonnes h 144 cm. En mélaminé mat Grigio scuro et Nuvola, avec top en stratifié hpl Noir Climb.





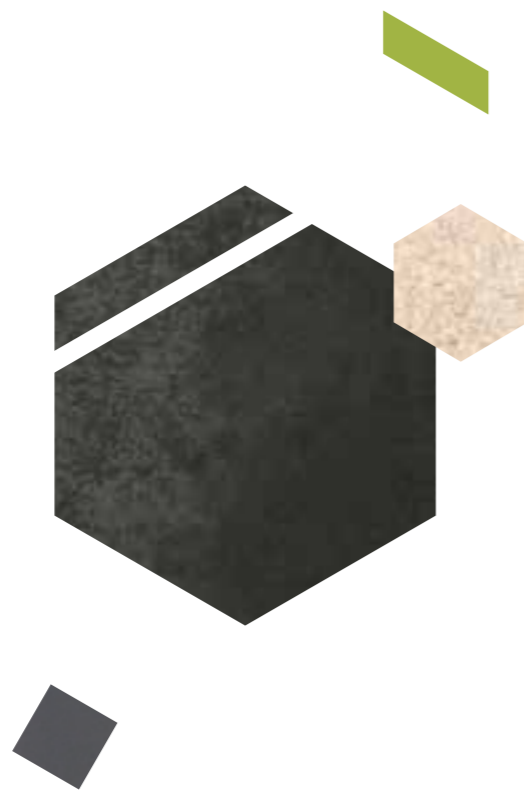

# TAU

Contemporary and refined, the Tau kitchen is the perfect place for preparing food and receiving guests. The laminated doors are highly resistant to use in the kitchen and create special atmospheres by means of a host of glossy or matt finishes and the exact reproduction of stone and wood. Such solutions give the kitchen character with elegant, prestigious units that fit into any modern ambience to reflect personal taste.

Contemporanea e raffinata, la cucina Tau diventa luogo eccellente dove misurarsi con il cibo e l'ospitalità. Le ante in laminato offrono la massima resistenza all'utilizzo nell'ambiente cucina e creano atmosfere singolari grazie alle svariate finiture, da lucide e opache, alle fedeli riproduzioni di pietre e legni. Soluzioni che caratterizzano la cucina con eleganza e prestigio, interpretandola per ambienti moderni e personalizzati.

Contemporaine et raffinée, la cuisine Tau devient un lieu excellent où se mesurer avec la nourriture et l'hospitalité. Les portes en stratifié offrent une résistance maximum à l'utilisation dans l'ambiance cuisine et créent des atmosphères singulières grâce aux différentes finitions, de brillantes à mates, aux reproductions fidèles de pierres et bois. Des solutions qui caractérisent la cuisine avec élégance et prestige, en l'interprétant pour des ambiances modernes et personnalisées.

COMPOSITION **01 | 02 | 03**

## Openings / Aperture / Ouvertures



## Thickness / Spessore / Epaisseur



## Finishings / Finiture / Finitions

Matt/glossy laminated   Laminato opaco/lucido   Stratifié mat / brillant

Fenix NTM®

Stone laminated   Laminato pietra   Stratifié pierre

Wood laminated   Laminato legno   Stratifié bois

Marble laminated   Laminato Marmo   Marbre laminated







Kitchen units with glossy laminate Ardesia base units and tall units in Quercia Grigia Laminate. This composition features a Sigma grip profile that reflects the strong character of Tau. Top in laminated hpl Grafite 1397.

Cucina con basi in Laminato Ardesia lucido e colonne in Laminato Quercia grigia. Una composizione con Gola Sigma che rispecchia il carattere deciso di Tau. Top in laminato hpl Grafite 1397.

Une cuisine avec des éléments bas en Stratifié Ardesia brillant et des colonnes en Stratifié Quercia Grigia. Une composition avec profil gorge Sigma qui reflète le caractère franc de Tau. Plan en stratifié hpl Grafite 1397.











**Tau** | COMPOSITION **02**

Kitchen units with push-pull door-opening mechanisms that help to create modern, minimalist styling. Fenix nero, with which all surfaces are covered, is an innovative material with excellent resistance to scratches and wear, matt in appearance and soft to the touch.

Cucina con meccanismi push-pull per l'apertura delle ante per un'estetica moderna e minimalista. Il Fenix nero, che ricopre tutte le superfici, è un innovativo materiale dalle eccellenti proprietà di resistenza al graffio e all'usura, morbido al tatto e opaco alla vista.

Une cuisine avec des mécanismes push-pull pour l'ouverture des portes pour une esthétique moderne et minimaliste. Le Fenix Nero, qui recouvre toute les superficies, est un matériau innovant aux propriétés excellentes de résistance aux rayures, doux au toucher et à l'aspect mat.





A new, innovative material, known as Fenix NTM®, enters the kitchen. This is an HPL laminate with a particularly matt appearance that provides advanced technological performance due to its surface and is available in 6 colour variants for tops and doors.

Un nuovo ed innovativo materiale entra a far parte dell'ambiente cucina, è il Fenix NTM®. Un Laminato HPL dal particolare aspetto opaco che offre prestazioni tecnologiche all'avanguardia grazie alle sue caratteristiche superficiali, disponibile in 6 varianti colore per top e anta.

Un matériau nouveau et innovant entre dans l'ambiance cuisine, c'est le Fenix NTM®. Un Stratifié HPL à l'aspect particulier mat qui offre des prestations technologiques à l'avant-garde à ses caractéristiques de surface, disponible dans 6 variantes de couleur pour plan et porte.







**Tau** | COMPOSITION **03**



In this kitchen the faithful reproduction of wood for the laminate Rovere Saraceno surface cover on the tall units is enlivened by Fenix Castoro on the doors and island work top. A composition featuring large Hole handles.

In questa cucina la fedele riproduzione del legno nel rivestimento in laminato Rovere Saraceno delle colonne vengono accompagnate dal calore del Fenix Castoro delle ante e del piano di lavoro dell'isola. Composizione in cui le ampie maniglie Hole diventano protagoniste.

Dans cette cuisine, la reproduction fidèle du bois dans le revêtement en stratifié Rovere Saraceno des colonnes est accompagnée par la chaleur du Fenix Castoro des portes et du plan de travail de l'îlot. Composition dans laquelle les larges poignées Hole deviennent protagonistes.







# YPSILON

Essential shapes, clean lines, architectures integrated with the living room. An ideal mix that is also practical and interprets the contemporary idea of family intimacy. Functional solutions inspired by a search for freely styled compositions in which refined design goes hand in hand with the new ways of using kitchens nowadays and in the future.

Forme essenziali, geometrie limpide, architetture integrate al living. Un'ideale di sintesi che rimanda alla praticità interpretando con gusto contemporaneo anche il piacere dell'intimità familiare. Soluzioni funzionali ispirate alla ricerca della massima libertà compositiva dove un design raffinato dialoga costantemente con un'estetica attenta ai nuovi modi di vivere l'ambiente cucina dell'oggi e del domani.

Des formes essentielles, des géométries limpides, des architectures intégrées au living. Un idéal de synthèses qui renvoie à l'aspect pratique en interprétant avec un goût contemporain également le plaisir de l'intimité familiale. Des solutions fonctionnelles inspirées par la recherche de la liberté maximum de composition, où un design raffiné dialogue constamment avec une esthétique attentive aux nouveaux modes de vivre l'ambiance cuisine d'aujourd'hui et de demain.

COMPOSITION **01 | 02 | 03 | 04 | 05**

## Openings / Aperture / Ouvertures



## Thickness / Spessore / Epaisseur



## Finishings / Finiture / Finitions

Flamed thermostructured melamine   Melaminico termostrutturato fiammato   Mélaminé thermostructuré, flammé  
 Knotted thermostructured melamine   Melaminico termostrutturato nodato   Mélaminé thermostructuré, avec noeuds  
 Serrated melamine   Melaminico seghettato   Mélamine tranché  
 Matt/glossy laquered   Laccato opaco/lucido   Laqué mat / brillant







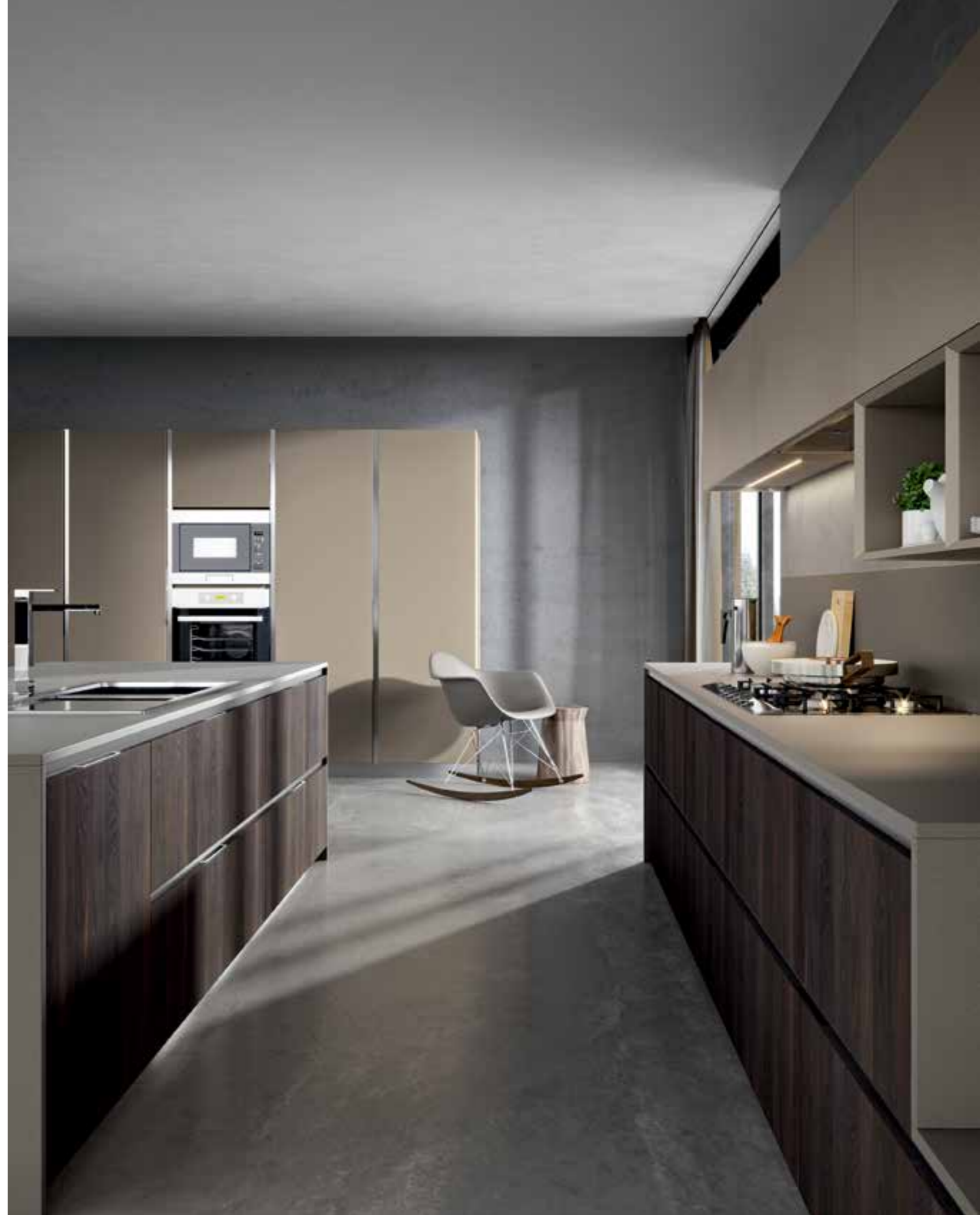

**Ypsilon** | COMPOSITION **01**

An atmosphere of natural elegance and strong personality is created by merging Fiammato Avana flamed melamine, matt lacquered Corda and the Silestone Unsui work top. The Inside handle is encased in the inside of the door. The result is harmonious use of materials that spell refinement.

Atmosfera di naturale eleganza e dal forte carattere, dettata dalla fusione del melaminico Fiammato Avana, il laccato opaco Corda e il piano di lavoro in Silestone Unsui. La maniglia Inside è incassata nella parte interna dell'anta. Un insieme armonioso di materiali all'insegna della raffinatezza.

Atmosphère d'élégance naturelle et au caractère fort, dictée par la fusion du mélaminé flammé Avana, le laqué mat Corda et le plan de travail en Silestone Unsui. La poignée Inside est encadrée dans la partie interne de la porte. Un ensemble harmonieux de matériaux à l'enseigne du raffinement.











A kitchen featuring an island that makes an important statement with its extra thick steel work top and integrated Terra wood veneered counter. The tall units are entirely in melamine knotted Nodato Grigio.

Cucina con isola che diventa protagonista della casa grazie al piano di lavoro in acciaio dal forte spessore e dal bancone in legno impiallacciato Terra integrato. Le colonne sono interamente rivestite dal melaminico Nodato Grigio.

Une cuisine avec îlot qui devient protagoniste de la maison grâce au plan de travail en acier de grande épaisseur et au comptoir en bois plaqué Terra intégré. Les colonnes sont entièrement revêtues de mélaminé Nodato Grigio avec nœuds.



 **Ypsilon** | COMPOSITION **02**









**Ypsilon** | COMPOSITION **03**

Composition in melamine thermostructured flamed Nocciola, featuring end elements for the base units and open units in the Tessuto finish.

Composizione in melaminico termostrutturato fiammato Nocciola che presenta, nelle parti terminali delle basi, vani a giorno nella finitura Tessuto.

Composition en mélaminé thermostructuré flammé Nocciola qui présente, dans les parties de terminaison des éléments bas, des compartiments ouverts dans la finition Tessuto.







Kitchen units in Seghettato Cenere, serrated melamine, for base units and wall units, with tall units in Neve glossy lacquered. The Ola handles, perfectly integrated, enhances the entire composition.

Cucina in melaminico Seghettato Cenere per basi e pensili con colonne in laccato lucido Neve. La maniglia Ola, perfettamente integrata nelle ante, impreziosisce la composizione.

Une cuisine en mélaminé tranché Sghettato Cenere pour éléments bas et hauts avec colonnes en laqué brillant Neve. La poignée Ola, parfaitement intégrée dans les portes, enrichit la composition.







The formal look of this composition features rounded ends on the base units, wall units and tall units. The fronts are glossy lacquered with Inox grip profiles; tops are in LG HI-MACS Alpine white.

L'aspetto formale di questa composizione è caratterizzato dalle parti terminali arrotondate presenti nelle basi nei pensili e nelle colonne. La finitura dei frontali è laccato lucido, gola in Inox e top in LG HI-MACS Alpine white.

L'aspect formel de cette composition est caractérisé par les parties de terminaison arrondies présentes dans les éléments bas, dans les éléments hauts et dans les colonnes. La finition des façades est en laqué brillant, profil gorge en Inox et plan en LG HI-MACS Alpine white.



Above, the curved ends that give this kitchen a unique appearance.  
The curved elements also include doors in a choice of lacquered colours for the Ypsilon model.

Sopra i terminali curvi che donano alla cucina un aspetto unico.  
Gli elementi curvi disponibili comprendono anche le ante,  
sempre nei colori laccati offerti dal modello Ypsilon.

Ci-dessus, les éléments de terminaison arrondis qui donnent à la  
cuisine un aspect unique.  
Les éléments arrondis disponibles comprennent également les  
portes, toujours dans les couleurs laquées offertes par le modèle  
Ypsilon.



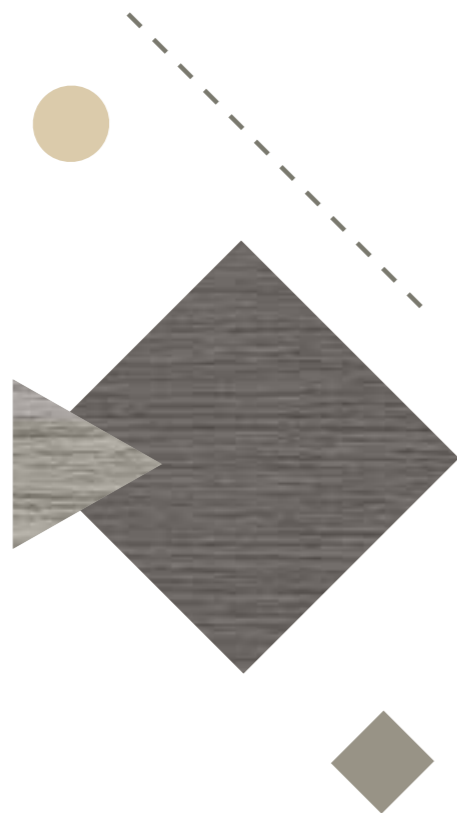

# KAPPA

With its strong character Kappa comprises affordable kitchen units and equipped modules, functional solutions and capacious storage units, and interprets a need for articulated, representative ambiances in line with modern lifestyles.

Forte nel carattere, Kappa è una cucina alla portata di tutti che con i suoi moduli attrezzati, le soluzioni funzionali e gli ampi contenitori, interpreta il bisogno di ambienti sempre più articolati e rappresentativi, consoni ai nuovi stili di vita contemporanei.

Forte dans le caractère, Kappa est une cuisine à la portée de tous qui, avec ses modules équipés, les solutions fonctionnelles et les larges espaces de rangement, interprète le besoin d'ambiances de plus en plus articulées et représentatives, correspondant aux nouveaux styles de vie contemporains.

COMPOSITION **01 | 02 | 03**

## Openings / Aperture / Ouvertures



## Thickness / Spessore / Epaisseur



## Finishings / Finiture / Finitions

UV glossy   UV Lucido   UV brillant

Larch melamine   Melaminico larice   Mélamine mélèze

Matt melamine   Melaminico opaco   Mélamine mat







Kitchen units in Larice Grigio melamine, harmoniously combined with Champagne UV lacquered. This lacquering method ensures highly glossed surfaces. The work top is in Silestone Merope.

Cucina in melaminico Larice Grigio che trova l'equilibrio grazie alla combinazione con il laccato Champagne UV. Metodo di laccatura che permette di ottenere un'elevato grado di lucentezza superficiale. Il piano di lavoro è in Silestone Merope.

Une cuisine en mélaminé Larice Grigio qui trouve son équilibre, grâce à la combinaison avec le laqué Champagne UV. Méthode de laquage qui permet d'obtenir un degré élevé de brillance superficielle. Le plan de travail est en Silestone Merope.

Suspended base units come with special attachments that make the kitchen appear airy and increase the composition opportunities for the Armony collection.

Le basi sospese sono dotate di apposite attaccaglie che permettono di ottenere una cucina esteticamente leggera e vanno ad aumentare le possibilità compositive della collezione Armony.

Les éléments bas suspendus sont dotés de fixations spéciales qui permettent d'obtenir une cuisine esthétiquement légère et augmentent la possibilité de composition de la collection Armony.









Kappa

COMPOSITION **02**



Matt Bianco Diamante melamine for fronts and Laminato Pietra piacentina for the work top. Merging these neutral shades links the kitchen with the surrounding architecture, enhancing and completing it.

Melaminico opaco Bianco Diamante per i frontale e Laminato Pietra piacentina per il piano di lavoro. La fusione di questi toni neutrali permette alla cucina di legarsi con l'architettura che la circonda, valorizzandola e completandola.

Méliné mat Bianco Diamante pour la façade et Stratifié Pietra piacentina pour le plan de travail. La fusion de ces tons neutres permet à la cuisine de se lier avec l'architecture qui l'entoure, en la valorisant et en la complétant.













Composition in Bianco diamante and Beige melamine with 6cm thick work top in Grigio Medio Climb Hpl laminate. Elegant colours that provide refinement in any situation bring importance and character to your home.

Composizione in melaminico Bianco diamante e Beige con piano di lavoro in laminato Hpl Grigio medio climb spessore 6 cm. Colori dell'eleganza, adatti a tutte le situazioni e sempre raffinati, si inseriscono con decisione e danno carattere e personalità alla propria casa.

Composition en mélaminé Bianco Diamante et Beige avec plan de travail en stratifié Hpl Grigio Medio Climb d'une épaisseur de 6 cm. Couleurs de l'élégance, adaptées à toutes les situations et toujours raffinées, qui s'insèrent avec décision et donnent caractère et personnalité à la maison.

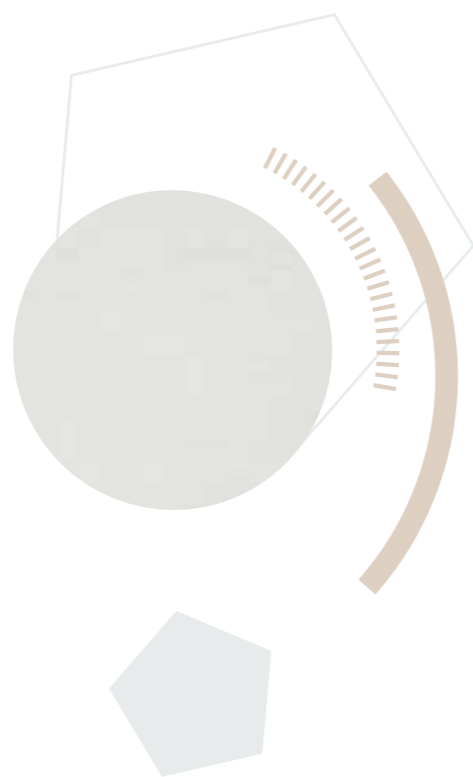

# PENTHA

Highly practical due to the handle profiles incorporated in the 22mm thick doors. This handle is the result of thorough research into ergonomics and is the distinguishing feature of this kitchen.

Massima praticità di utilizzo grazie alla presa maniglia ricavata sull'anta di spessore 22 mm. Maniglia che nasce da un approfondito studio ergonomico e che diventa per questo il tratto distintivo della cucina.

Commodité maximum d'utilisation grâce à la prise poignée située sur la porte de 22 mm d'épaisseur. Poignée qui nait d'une étude ergonomique approfondie et qui devient ainsi le signe distinctif de la cuisine.

COMPOSITION **01 | 02**

## Openings / Aperture / Ouvertures



## Thickness / Spessore / Epaisseur



## Finishing / Finiture / Finitions

Matt/glossy laquered   Laccato opaco/lucido   Laqué mat/brillant

Ecowood







**Pentha** | COMPOSITION **01**

Kitchen units with Neve glossy lacquered doors and a distinctive stainless steel top with integrated sink and cooking hob. These are joined by invisible welding that gives the composition a modern, minimalist look.

Cucina con ante in finitura laccato lucido Neve e caratterizzata dal top in acciaio inox che integra lavello e piano cottura. Questi, uniti da saldature invisibili, rendono la composizione moderna e minimalista.

Une cuisine avec porte en finition laqué brillant Neve et caractérisée par le plan en acier inox qui intègre évier et plan cuisson. Ces derniers, unis par des soudures invisibles, rendent la composition moderne et minimaliste.



The H.144cm tall units and H.15cm plinths define the kitchen area without the need for partition walls, a solution made possible by the wide range of modules and combinations in the Armony collection.

Le colonne h144 cm e lo zoccolo h15 cm delimitano lo spazio della cucina senza l'ausilio di pareti divisorie. Una soluzione possibile grazie alla vasta gamma di moduli e combinazioni presenti nella collezione Armony.

Les colonnes h144 cm et le socle h15 cm délimitent l'espace de la cuisine sans l'aide de cloisons de séparation. Une solution possible grâce à la vaste gamme de modules et de combinaisons présentes dans la collection Armony.









Kitchen units featuring the Pentha groove that allows doors to be opened without the use of grip profiles or handles, creating stunning, uncluttered good looks. Made of Ecowood Diamant with horizontal grain and matt lacquered Pomice.

Cucina caratterizzata dalla presa maniglia Pentha che permette l'apertura delle ante senza l'utilizzo di gole o maniglie, per una pulizia estetica massima. Realizzata in Ecowood Diamant con vena orizzontale e laccato opaco Pomice.

Une cuisine caractérisée par la prise poignée Pentha qui permet l'ouverture des portes sans l'utilisation de profils gorge ou poignées, pour une sobriété esthétique maximum. Réalisée en Ecowood Diamant avec veine horizontale et laqué mat Pomice.



Pentha

COMPOSITION **02**







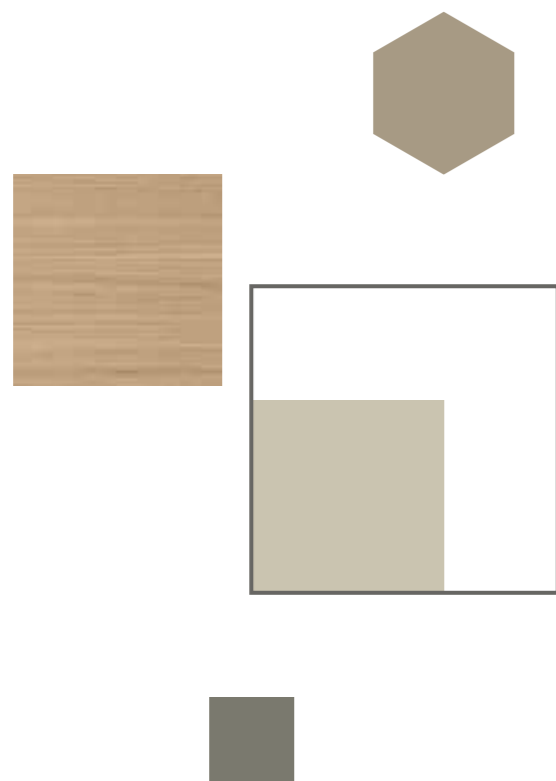

# DIADEMA

Uninterrupted links between classical and modern taste. The Diadema kitchen features solid oak framed doors, available not only in Naturale serrated oak, but also in a lacquered version which brings a contemporary note to a cosy atmosphere.

Un dialogo continuo e ininterrotto tra gusto classico e attualità. La cucina Diadema è caratterizzata da ante telaio massiccio di rovere disponibili non solo in rovere seghettato Naturale ma anche nella versione laccata, riuscendo in questo modo ad inserire note di contemporaneità in un'atmosfera accogliente.

Un dialogue continu et interrompu entre le goût classique et l'actualité. La cuisine Diadema est caractérisée par des portes châssis chêne rouvre massif disponibles non seulement en chêne rouvre tranché Naturelle mais également dans la version laquée, en parvenant ainsi à insérer des notes contemporaines dans une atmosphère accueillante.

COMPOSITION **01**

## Openings / Aperture / Ouvertures



## Thickness / Spessore / Epaisseur



## Finishings / Finiture / Finitions

Matt laquered   Laccato opaco   Laqué mat

Serrated oak   Rovere seghettato   Chêne tranché







Diadema

COMPOSITION **01**



Refined, classical solid oak framed door revisited in contemporary style. The Bold black handles contrast with the Naturale serrated oak used also for the integrated table.

Raffinata anta con telaio in rovere massiccio dal gusto classico rivisitato in chiave contemporanea. Le maniglie Bold nere contrastano con il rovere seghettato Naturale, che troviamo anche nel tavolo integrato.

Porte raffinée avec châssis en chêne rouvre massif au goût classique révisité en version contemporaine. Les poignées Bold noires contrastent avec le chêne rouvre tranché Naturale, que nous trouvons également dans la table intégrée.



The work top is in Silestone Amazon, an agglomerate featuring great scratch resistance and antibacterial protection for surfaces.

Il piano di lavoro è in Silestone Amazon, agglomerato caratterizzato dall'elevata resistenza al graffio che offre una protezione antibatterica attiva della superficie.

Le plan de travail est en Silestone Amazon, aggloméré caractérisé par la résistance élevée aux rayures qui offre une protection antibactérienne active de la superficie.





# QUADRATIKA

A kitchen that offers innovative solutions, it provides a link with the past while staying firmly rooted in the present. The classic inspiration is evident in the design of the fronts and the use of solid wood frames, while the rest of the kitchen – island, storage cabinets and accessories – is contemporary and multifunctional.

Una cucina dalle soluzioni innovative che sa conservare un legame con la tradizione rimanendo allo stesso tempo attuale. La dimensione classica si racconta nel design delle ante e nella scelta di un telaio massiccio, tutto il resto – isola, contenitori e accessori – traduce un linguaggio contemporaneo e multifunzionale.

Une cuisine aux solutions innovantes qui sait conserver un lien avec la tradition tout en restant actuelle. La dimension classique transparait dans le design des portes et dans le choix d'un cadre massif, tout le reste - îlot, meubles et accessoires - parle une langue contemporaine et multifonctionnelle.

COMPOSITION **01**

## Openings / Aperture / Ouvertures



## Thickness / Spessore / Epaisseur



## Finishings / Finiture / Finitions

Matt oak   Rovere opaco   Chêne mat







## Quadratika | COMPOSITION **01**

Veneered door with a raised centre panel as its distinguishing feature. In matt rovere Oliva with Fenix Bianco malé work top.

Anta impiallacciata segnata dal pannello centrale in rilievo che ne caratterizza il modello. In rovere opaco Oliva con piano di lavoro in Fenix Bianco malé.

Porte plaquée marquée par le panneau central en relief qui en caractérise le modèle. En chêne rouvre mat Oliva avec plan de travail en Fenix Bianco malé.

RIASSUNTO / RESUME

---

# SUMMARY





# Yota

## COMPOSITION 01



- 1135 Neve**  
Laquered / Laccato / Laqué
- Oliva 3009**  
Oak / Rovere / Chêne
- Alpine white**  
LG HI-MACS

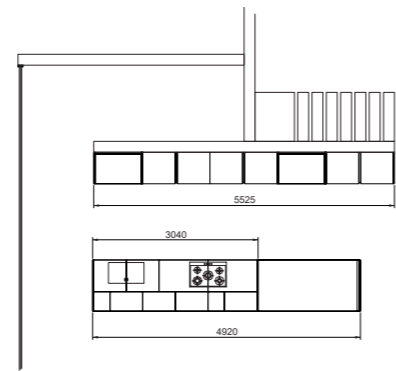

# Yota

## COMPOSITION 02



- 1137 Moka**  
Laquered / Laccato / Laqué
- 1154 Titanio**  
Laquered / Laccato / Laqué
- Botticino**  
Laminato / Laminated / Stratifié
- Trento**  
Vintage wood / Legno vintage / Bois vieilli

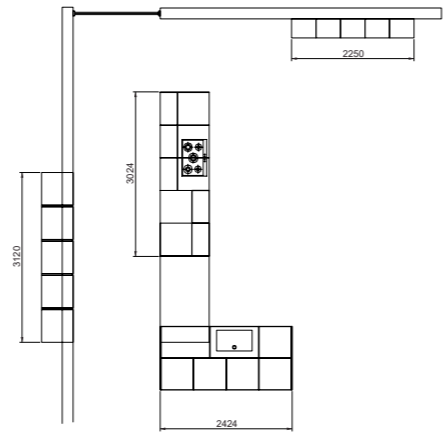

# Yota

## COMPOSITION 03



- 1235 Neve**  
Laquered / Laccato / Laqué
- 1357 Iron**  
Laquered / Laccato / Laqué
- Aura 15**  
Dekton
- Quercia**  
Ancient wood / Legno antico / Old bois

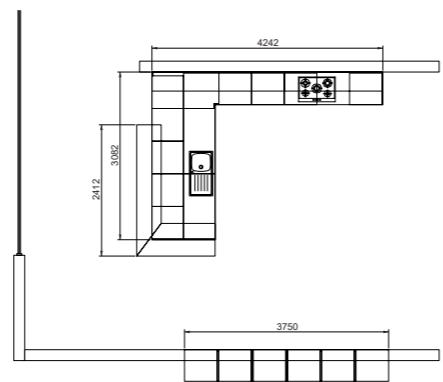

# Yota

## COMPOSITION 04



- 1135 Neve**  
Laquered / Laccato / Laqué
- Gianduia 2907**  
Oak / Rovere / Chêne
- Nero**  
FENIX NTM®
- 1124 Nero**  
Laquered / Laccato / Laqué

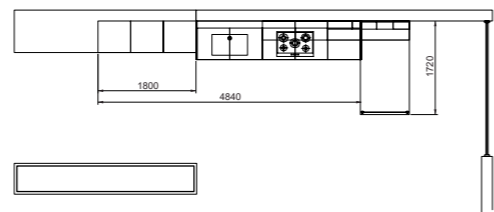

# Omicron 22

## COMPOSITION 01



- 1227 Grigio fumo**  
Laquered / Laccato / Laqué
- Antracite**  
Gres
- Abete Nero**  
Ancient wood / Legno antico / Old bois

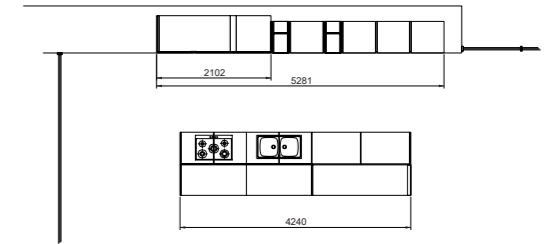

# Omicron 22

## COMPOSITION 02



- 1155 Grigio metro**  
Laquered / Laccato / Laqué
- Emperador**  
Gres
- Oliva 3009**  
Oak / Rovere / Chêne

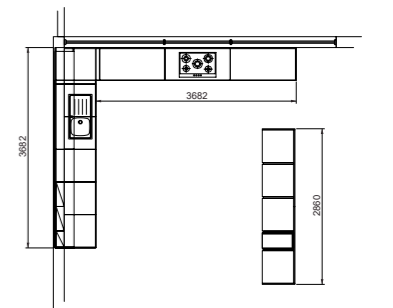

# Omicron 22

## COMPOSITION 03



- 1135 Neve**  
Laquered / Laccato / Laqué
- Noce scuro**  
Melamine / Melaminico / Melamine

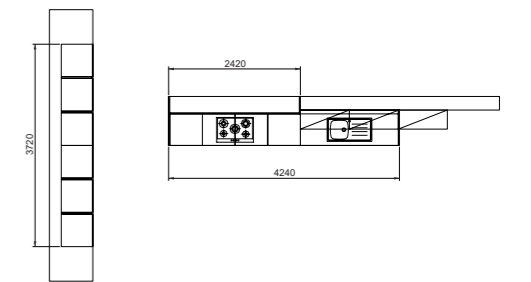

# Omicron 22

## COMPOSITION 04



- Caffè 2906**  
Oak / Rovere / Chêne
- Dark grey**  
Cemento

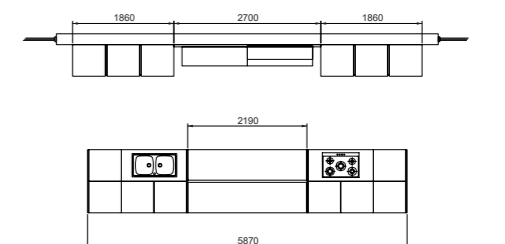

**T16** | COMPOSITION **01**



- Bianco moon OP** / Titan OP  
Matt glass / Vetro opaco / Verre mat
- Terra** / Bianco statuario  
Gres
- Limo 3008**  
Oak / Rovere / Chêne

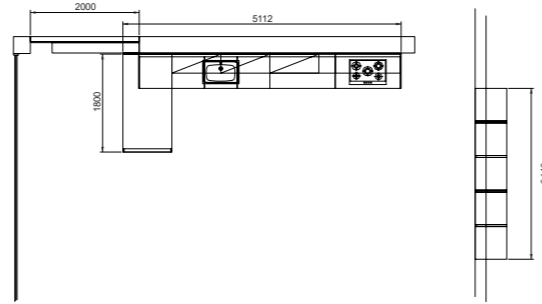

**Rho** | COMPOSITION **02**



- Fumo**  
Melamine / Melaminico / Melamine
- Moon**  
Melamine / Melaminico / Melamine
- Absolute blanc**  
Compac

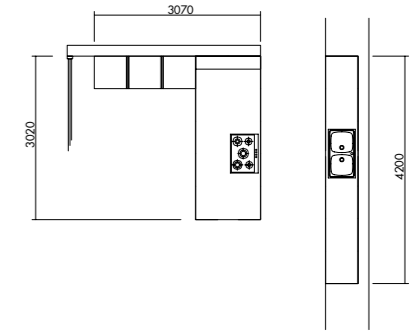

**T16** | COMPOSITION **02**



- Titan OP**  
Matt glass / Vetro opaco / Verre mat
- Antracite**  
Gres

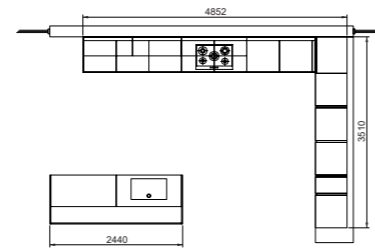

**Rho** | COMPOSITION **03**



- Sablé grigio**  
Melamine / Melaminico / Melamine
- Nero**  
FENIX NTM®
- Latte**  
Maxximatt

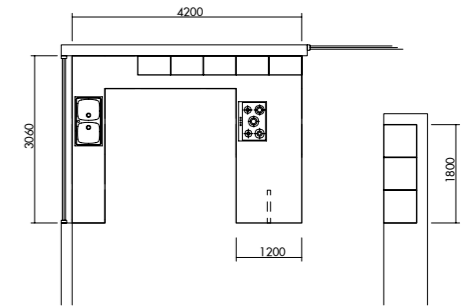

**T16** | COMPOSITION **03**



- Grafite LU**  
Glossy glass / Vetro lucido / Verre brillant
- Limo 3008**  
Oak / Rovere / Chêne
- Nero antracite**  
Lapitec

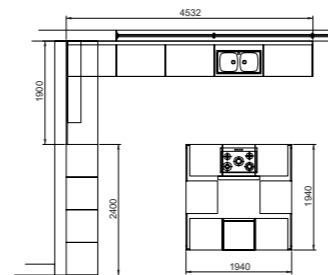

**Rho** | COMPOSITION **04**



- Mocaccino**  
Maxxigloss
- Stromboli**  
Laminated / Laminato / Laminated

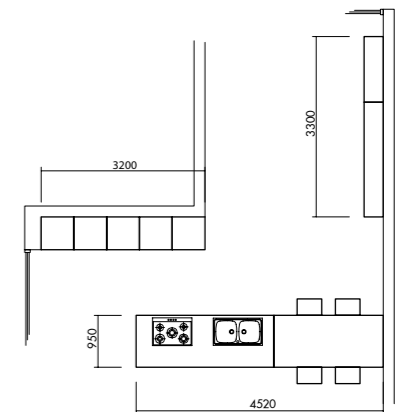

**Rho** | COMPOSITION **01**



- Eucalipto grigio**  
Melamine / Melaminico / Melamine
- Cachemire**  
Melamine / Melaminico / Melamine
- Galema**  
Dekton

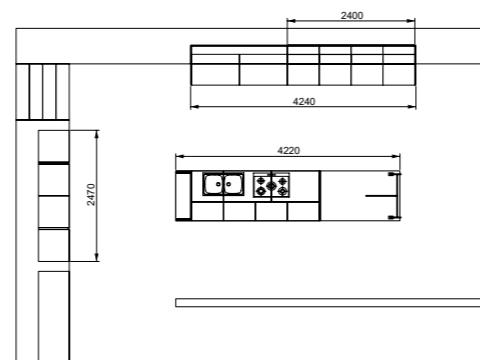

**Rho** | COMPOSITION **05**



- Noce canaletto**  
Melamine / Melaminico / Melamine
- Bianco alaska**  
FENIX NTM®
- Latte**  
Maxximatt

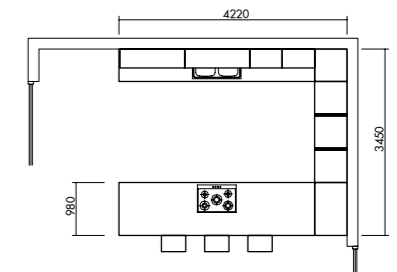



**Rho** | COMPOSITION **06**



**Grigio scuro**  
Melamine / Melamminico / Melamine

**Nero**  
FENIX NTM®

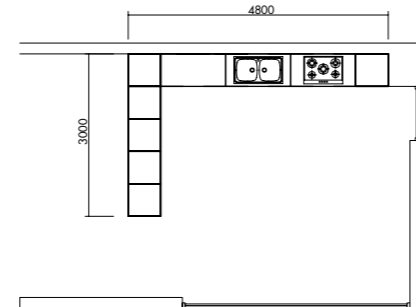

**Tau** | COMPOSITION **01**



**Ardesia 879 LU**  
Laminato / Laminated / Stratifié

**Quercia grigia**  
Laminato / Laminated / Stratifié

**Grafite 1397**  
Laminato / Laminated / Stratifié

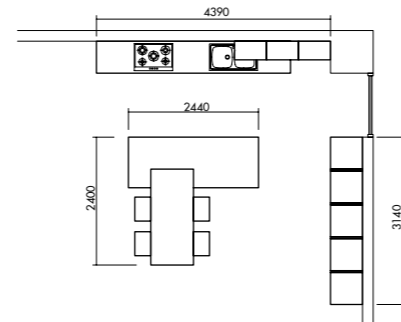

**Tau** | COMPOSITION **02**



**Nero**  
FENIX NTM®

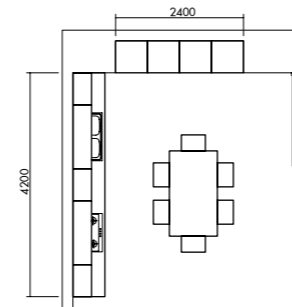

**Tau** | COMPOSITION **03**



**Rovere saraceno**  
Laminato / Laminated / Stratifié

**Quercia miele**  
Laminato / Laminated / Stratifié

**Castoro**  
FENIX NTM®

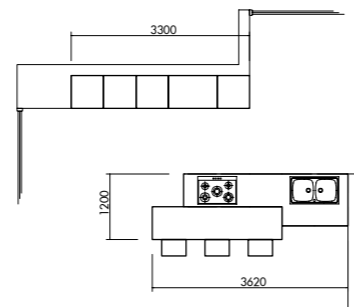

**Ypsilon** | COMPOSITION **01**



**1123 Corda**  
Laquered / Laccato / Laqué

**Fiammato avana**  
Melamine / Melamminico / Melamine

**Unsui**  
Silestone

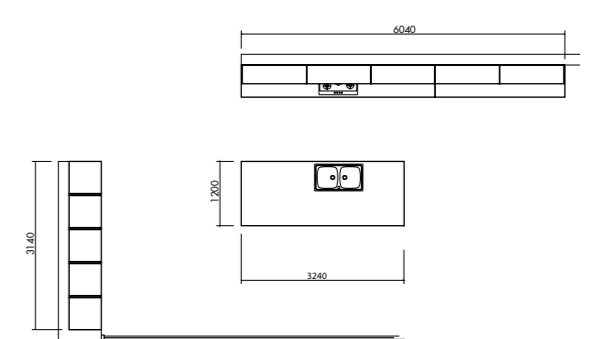

**Ypsilon** | COMPOSITION **02**



**1135 Neve**  
Laquered / Laccato / Laqué

**Nodato grigio**  
Melamine / Melamminico / Melamine

**Terra 2904**  
Oak / Rovere / Chêne

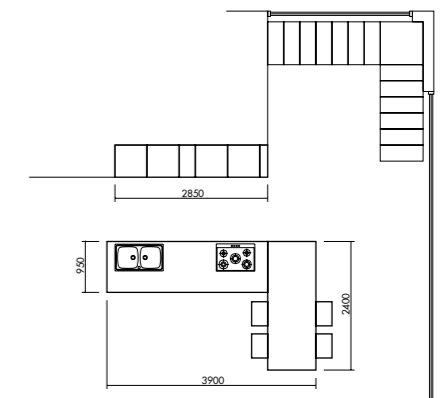

**Ypsilon** | COMPOSITION **03**



**Fiammato nocciola**  
Melamine / Melamminico / Melamine

**Terra 2904**  
Oak / Rovere / Chêne

**Esterel 6056**  
Laminato / Laminated / Stratifié

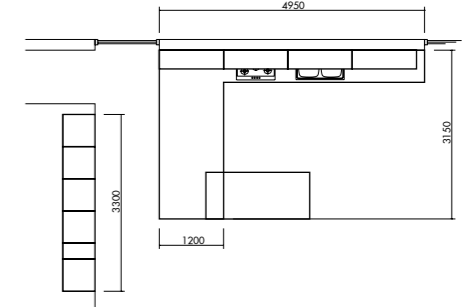

**Ypsilon** | COMPOSITION **04**



**Seghettato cenere**  
Melamine / Melamminico / Melamine

**1201 Bianco**  
Laquered / Laccato / Laqué

**Bianco Ghiaccio 410**  
Laminato / Laminated / Stratifié

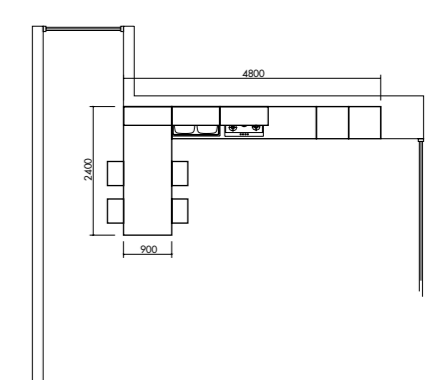

**Ypsilon** | COMPOSITION **05**



**1235 Neve**  
Laquered / Laccato / Laqué

**RAL 7010**  
Laquered / Laccato / Laqué

**Alpine white**  
LG HI-MACS

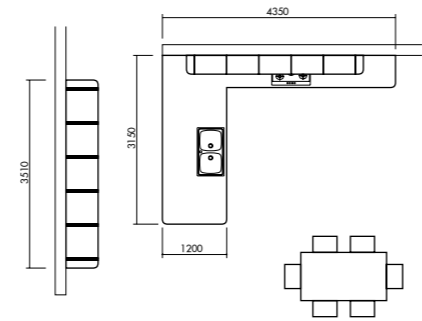

**Pentha** | COMPOSITION **01**



**1235 Neve**  
Laquered / Laccato / Laqué

**Stainless steel**  
Stainless steel / Acciaio Inox / Acier Inox

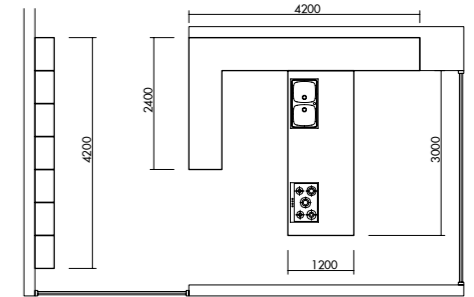

**Kappa** | COMPOSITION **01**



**Larice grigio**  
Melamine / Melaminico / Melamine

**Champagne UV**  
Laquered / Laccato / Laqué

**Merope**  
Silestone

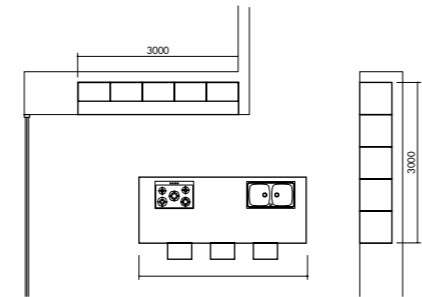

**Pentha** | COMPOSITION **02**



**Diamant**  
Ecowood

**Pomice**  
Laquered / Laccato / Laqué

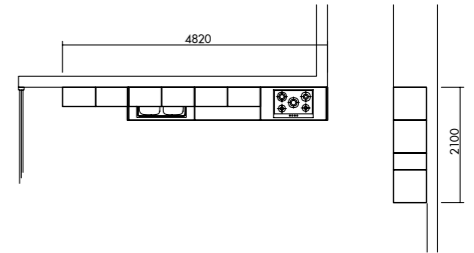

**Kappa** | COMPOSITION **02**



**Bianco Ghiaccio 410**  
Laminato / Laminated / Stratifié

**Bianco diamante**  
Melamine / Melaminico / Melamine

**Beige**  
Melamine / Melaminico / Melamine

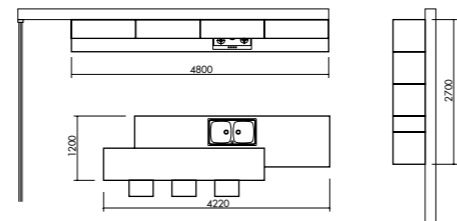

**Diadema** | COMPOSITION **01**



**Naturale 3011**  
Oak / Rovere / Chêne

**Amazon**  
Silestone

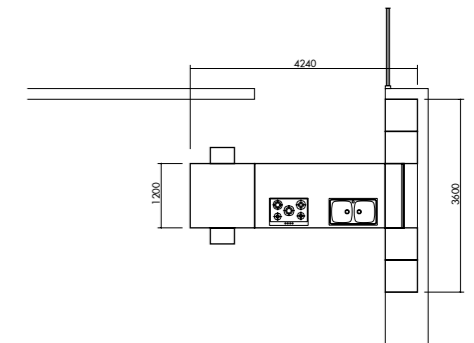

**Kappa** | COMPOSITION **03**



**Bianco diamante**  
Melamine / Melaminico / Melamine

**Beige**  
Melamine / Melaminico / Melamine

**Grigio medio 868**  
Laminato / Laminated / Stratifié

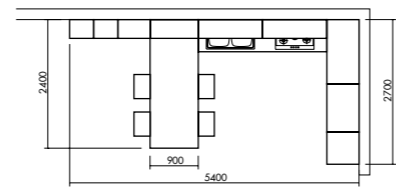

**Quadratika** | COMPOSITION **01**



**Oliva 2119**  
Oak / Rovere / Chêne

**Bianco malé**  
FENIX NTM®

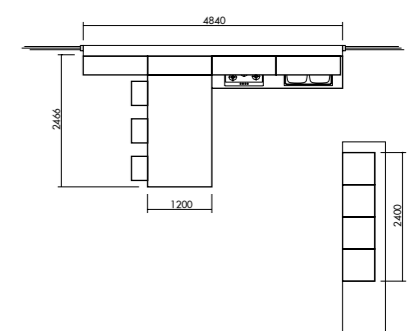



FINITURE / FINITIONS

---

# FINISHINGS

Flamed oak / Rovere fiammato / Chêne flammé



Knotted oak / Rovere nodato / Chêne avec noeuds



Serrated oak / Rovere seghettato / Chêne tranché

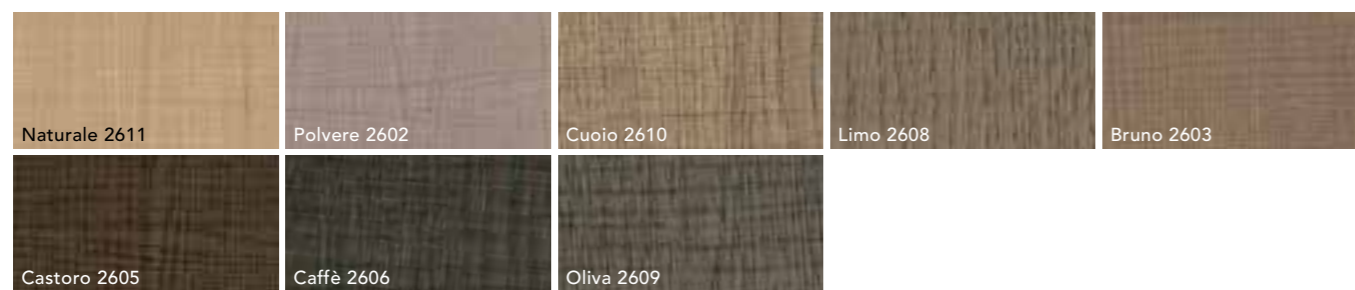

Concrete / Resina cemento / Résine cimentée



FENIX NTM



Matt laquered / Laccato opaco / Laqué mat



Glossy laquered / Laccato lucido / Laqué brillant



Matt laquered (Pentha) / Laccato opaco (Pentha) / Laqué mat (Pentha)

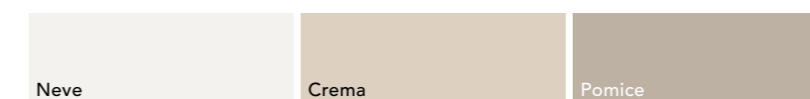

Glossy laquered (Pentha) / Laccato lucido (Pentha) / Laqué brillant (Pentha)

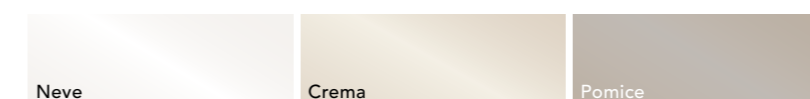

Also available for tops  
Disponibile anche per Top  
Disponible également pour Plan

Available exclusively for Top  
Disponibile esclusivamente per Top  
Disponible exclusivement pour Plan

Available exclusively for Snack counters  
Disponibile esclusivamente per Snack  
Disponible exclusivement pour Snack



LAQUARED

Metallic laquered / Laccato metallizzato / Laqué métallisé brillant



Vintage laquered / Laccato Vintage / Laqué Vintage



Glossy UV laquered / Laccato UV Lucido / UV brillant

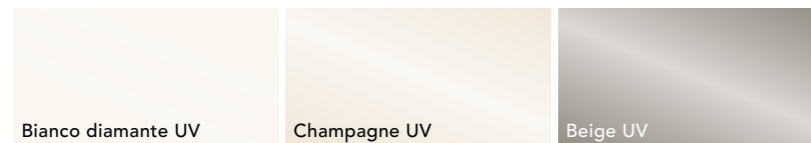

Maxxigloss®

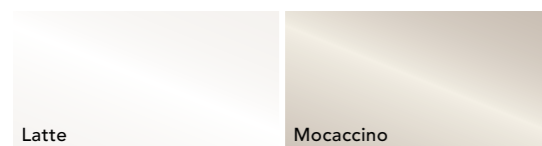

Maxximatt®

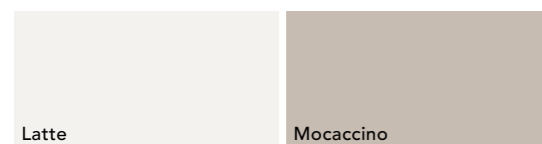

HPL LAMINATE

HPL laminated / Laminato HPL / Stratifié HPL

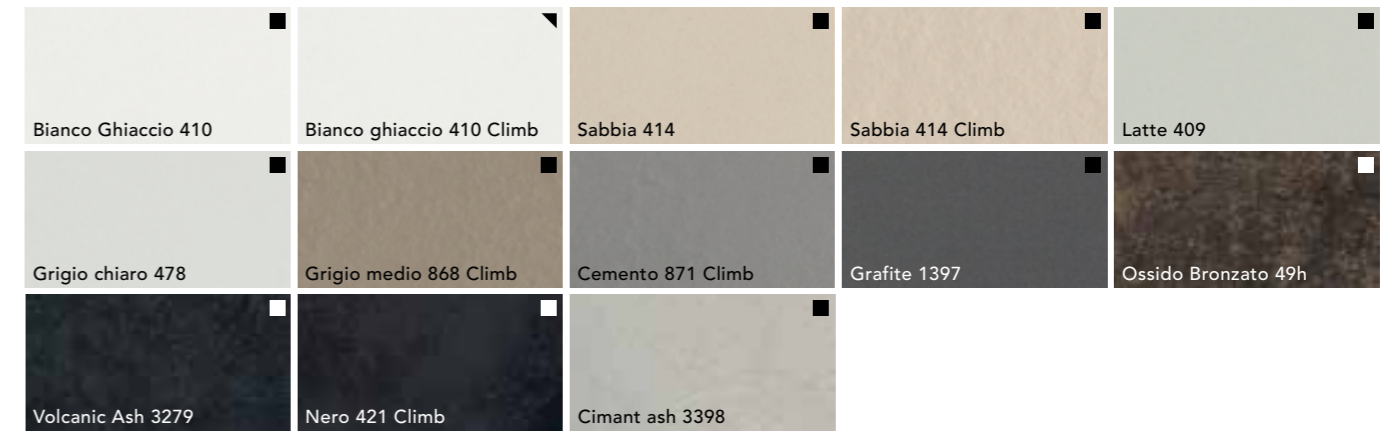

Stone laminated / Laminato pietra / Stratifié pierre

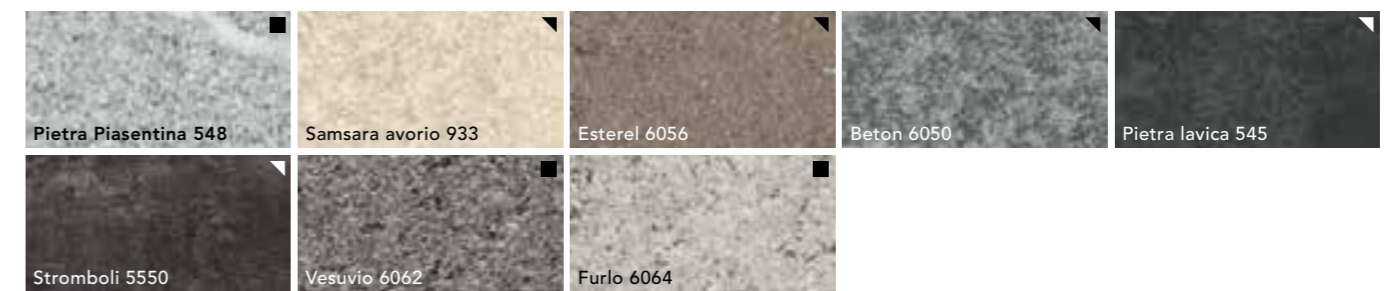

Wood laminated / Laminato legno / Stratifié bois

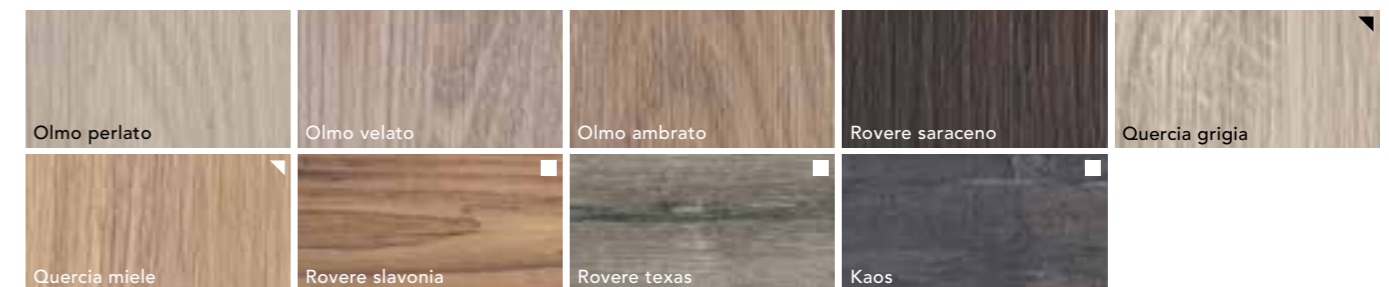

Marble laminated / Laminato marmo / Stratifié marbre

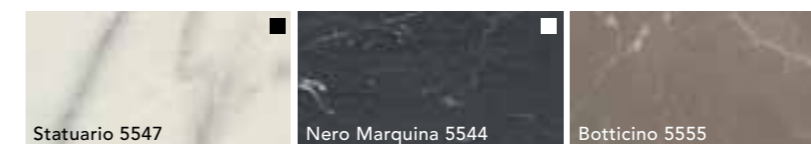

▾ Also available for tops  
 Disponibile anche per Top  
 Disponible également pour Plan

■ Available exclusively for Top  
 Disponibile esclusivamente per Top  
 Disponible exclusivement pour Plan

□ Available exclusively for Snack counters  
 Disponibile esclusivamente per Snack  
 Disponible exclusivement pour Snack

LAMINATE / UNICOLOR HPL

Matt laminated / Laminato opaco / Stratifié mat

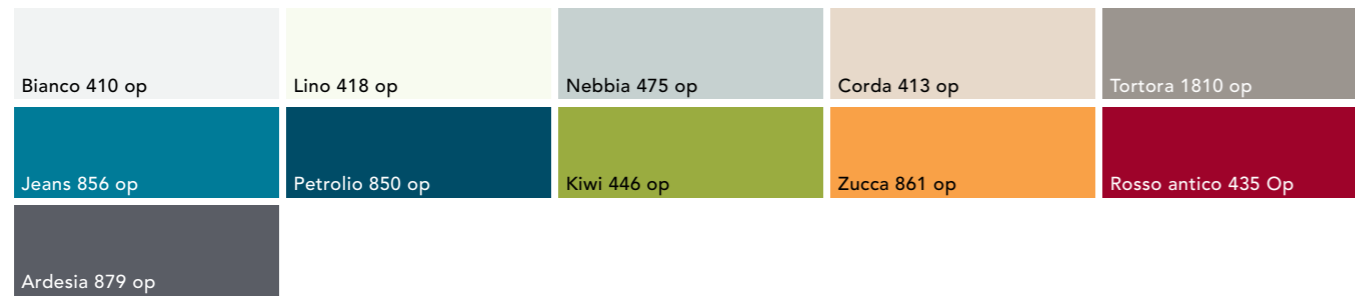

Glossy laminated / Laminato lucido / Stratifié brillant

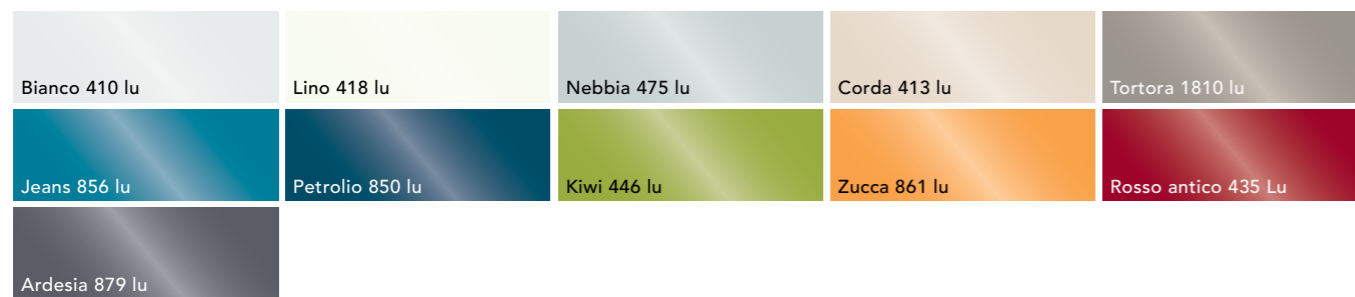

Unicolor HPL

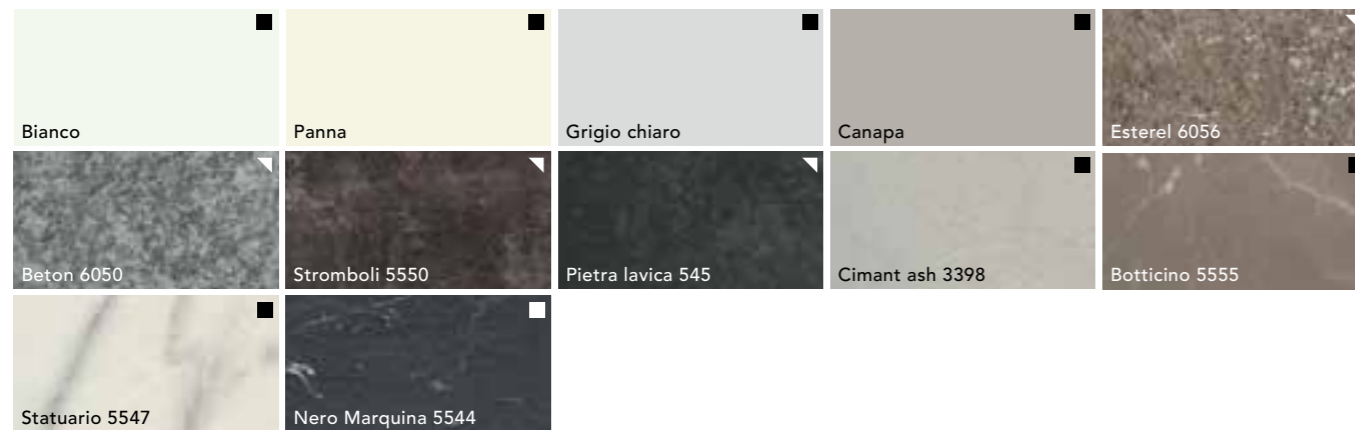

MELAMINE

Larch melamine / Melaminico larice / Mélamine mélèze



Matt melamine / Melaminico opaco / Mélamine mat

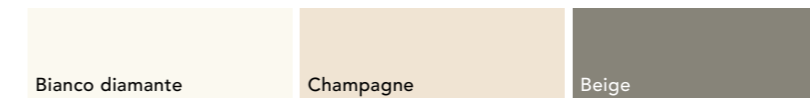

Matt melamine, skin finishing / Melaminico opaco, finitura skin / Mélaminé mat, finition skin

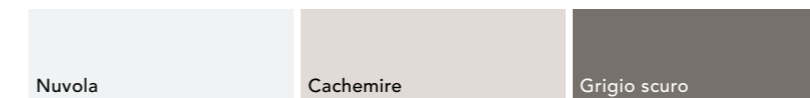

Serrated melamine / Melaminico seghettato / Mélamine tranché



Flamed, thermostructured melamine / Melaminico termostrutturato, fiammato / Mélaminé thermostructuré, flammé

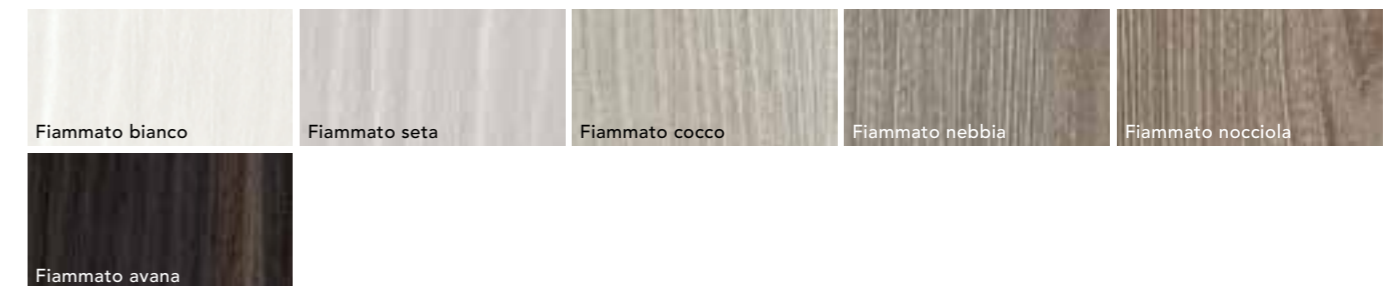

Knotted thermostructured melamine / Melaminico termostrutturato, nodato / Mélaminé thermostructuré, avec noeuds

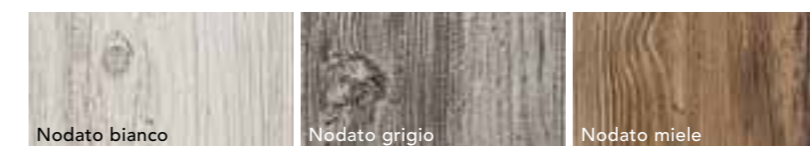

▲ Also available for tops  
Disponibile anche per Top  
Disponible également pour Plan

■ Available exclusively for Top  
Disponibile esclusivamente per Top  
Disponible exclusivement pour Plan

□ Available exclusively for Snack counters  
Disponibile esclusivamente per Snack  
Disponible exclusivement pour Snack



MELAMINE

Thermostructured melamine, sablé finishing / Melaminico termostrutturato, finitura sablé / Mèlaminé thermostructuré, finition sablé



Horizontal knotted, thermostructured melamine / Melaminico termostrutturato, nodato orizzontale / Mèlaminé thermostructuré, avec noeuds horizontal



Melamine, walnut finish / Melaminico, finitura noce / Mèlaminé, finition noyer

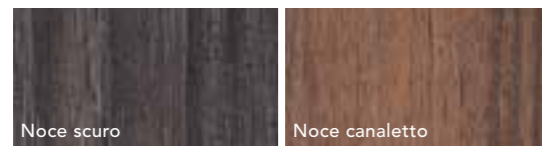

Thermostructured melamine, Eucalyptus finish / Melaminico termostrutturato, finitura Eucalipto / Mèlaminé thermostructuré, finition eucalyptus

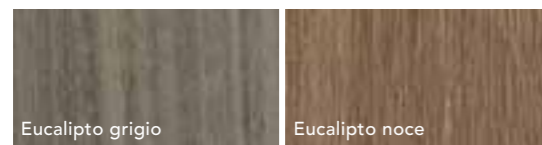

Thermostructured melamine, concrete finishing / Melaminico termostrutturato, finitura cemento / Mèlaminé thermostructuré, finition béton

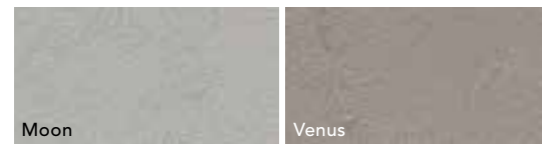

Ecwood (Pentha)

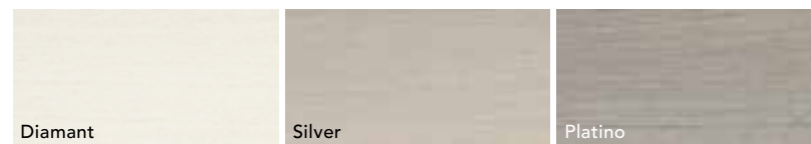

VINTAGE WOOD / ANCIENT WOOD / GRANITE / MARBLE / COMPAC

Vintage wood / Legno vintage / Bois vieilli



Ancient wood / Legno antico / Old bois



Granite / Granito / Granit

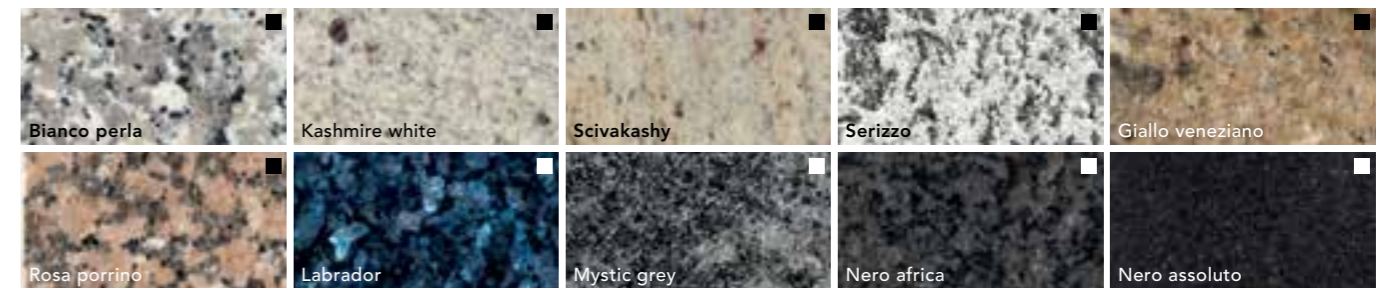

Marble / Marmo / Marbre

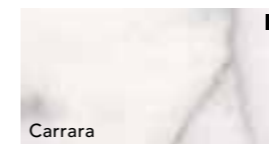

Compac

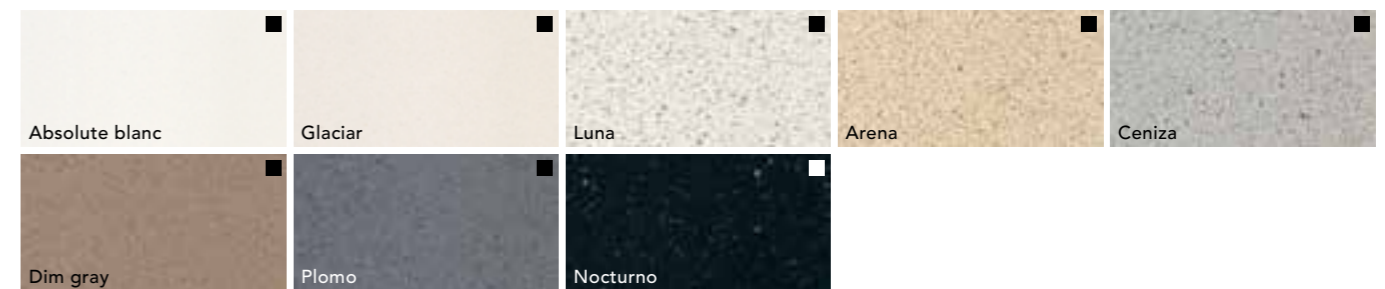

▾ Also available for tops  
Disponibile anche per Top  
Disponible également pour Plan

■ Available exclusively for Top  
Disponibile esclusivamente per Top  
Disponible exclusivement pour Plan

□ Available exclusively for Snack counters  
Disponibile esclusivamente per Snack  
Disponible exclusivement pour Snack

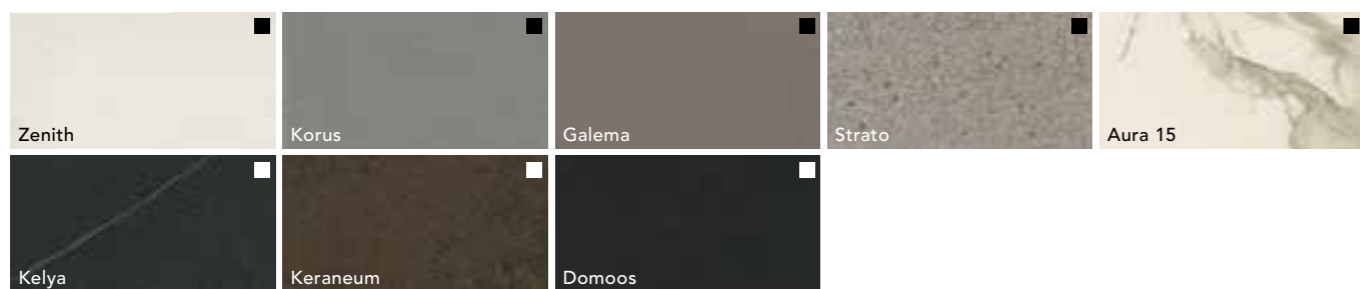
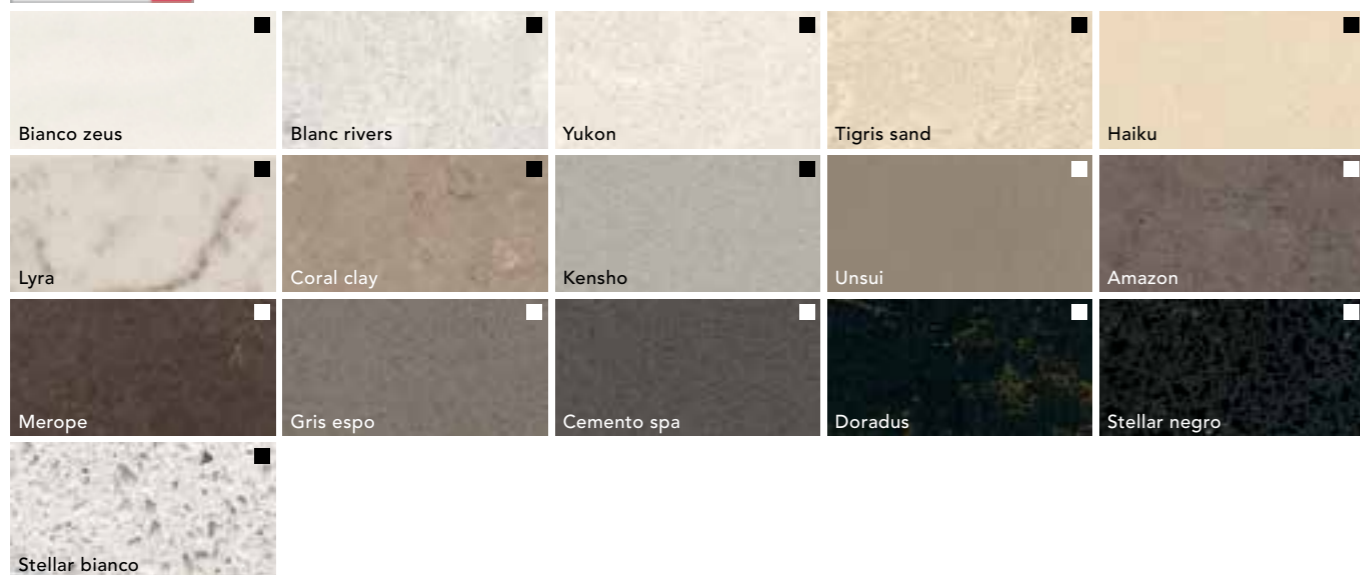

Gres

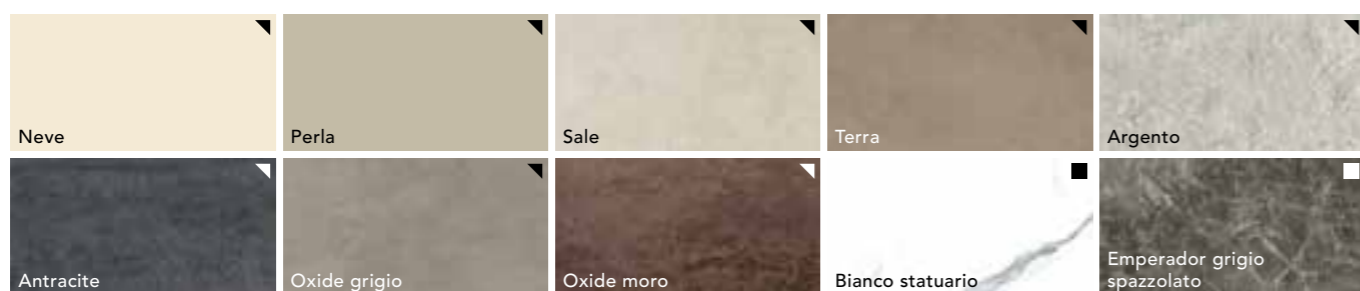

Acrylic / Acrilico / Acrylique

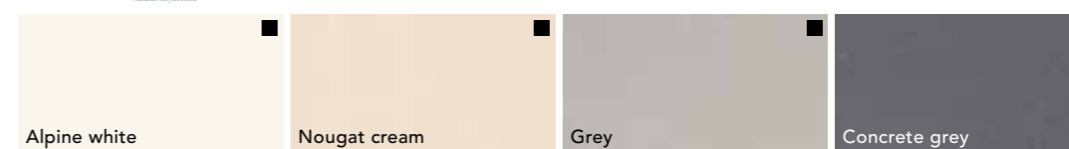
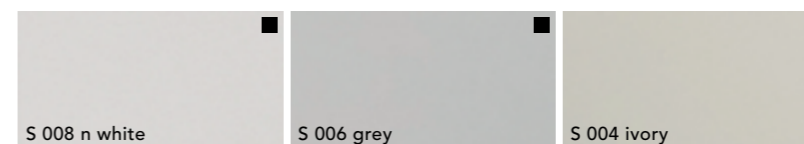

Matt tempered glass / Vetro opaco temperato / Verre trempé mat

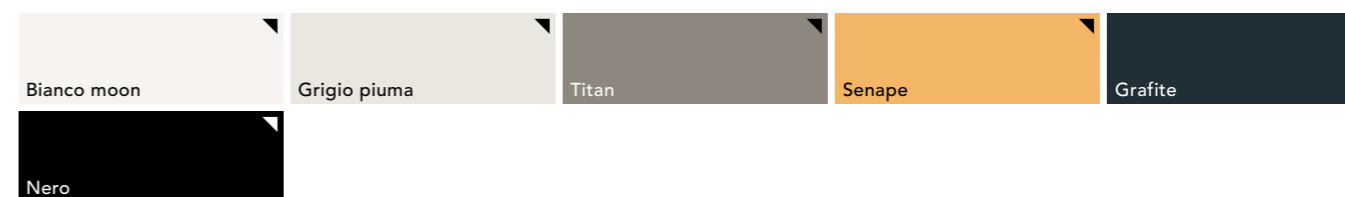

Glossy tempered glass / Vetro lucido temperato / Verre trempé brillant

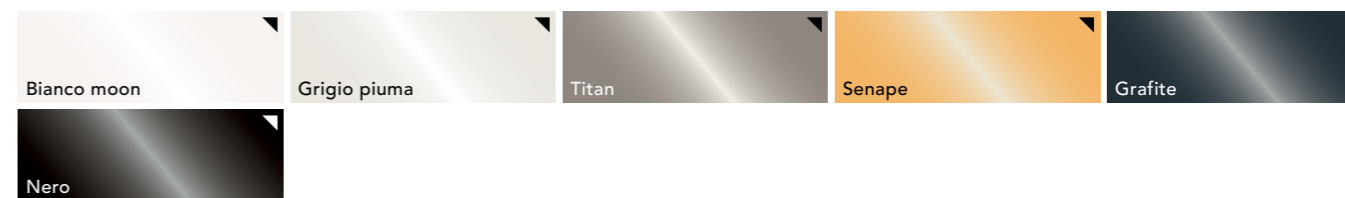

Stainless steel / Acciaio Inox / Acier Inox



▲ Also available for tops  
Disponibile anche per Top  
Disponible également pour Plan

■ Available exclusively for Top  
Disponibile esclusivamente per Top  
Disponible exclusivement pour Plan

□ Available exclusively for Snack counters  
Disponibile esclusivamente per Snack  
Disponible exclusivement pour Snack



DETTAGLI CUCINE / DETAIL CUISINES

---

# KITCHEN DETAILS

# YOTA

## Finishings / Finiture / Finitions

Matt / glossy laquered  
Laccato opaco / lucido  
Laqué mat / brillant

Glossy metallic laquered  
Laccato metallizzato  
Laqué métallisé brillant

Vintage laquered  
Laccato Vintage  
Laqué Vintage

Flamed oak  
Rovere fiammato  
Chêne flammé

Knotted oak  
Rovere nodato  
Chêne avec noeuds

Serrated oak  
Rovere seghettato  
Chêne tranché

## Openings / Aperture / Ouvertures

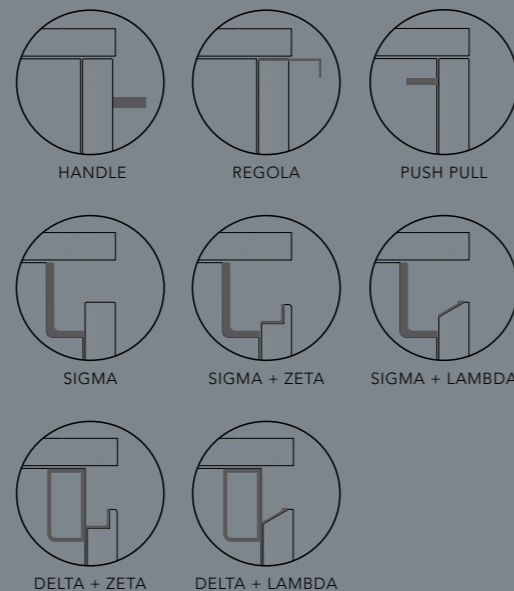

Door thickness / Spessore anta / Epaisseur de la porte 22mm

# OMICRON 22

## Finishings / Finiture / Finitions

Matt / glossy laquered  
Laccato opaco / lucido  
Laqué mat / brillant

Glossy metallic laquered  
Laccato metallizzato  
Laqué métallisé brillant

Vintage laquered  
Laccato Vintage  
Vintage laquered

Flamed / knotted / serrated oak  
Rovere fiammato / nodato / seghettato  
Chêne flammé / avec noeuds / tranché

Thermostructured melamine, concrete / sablé / eucalyptus finish  
Melaminico termostrutturato, finitura cemento / sablé / eucalipto  
Mélaminé thermostructuré, finition béton / sablé / eucalyptus

Melamine, walnut finish  
Melaminico, finitura noce  
Mélaminé, finition noyer

Horizontal knotted, thermostructured melamine  
Melaminico termostrutturato, nodato orizzontale  
Mélaminé thermostructuré, avec noeuds horizontal

Matt melamine, skin finish  
Melaminico opaco, finitura skin  
Mélaminé mat, finition skin

Concrete  
Resina Cemento  
Résine cimentée

## Openings / Aperture / Ouvertures

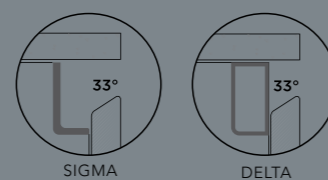

Door thickness / Spessore anta / Epaisseur de la porte 22mm

# T16

## Finishings / Finiture / Finitions

Matt tempered glass  
Vetro temperato opaco  
Verre trempé mat

Glossy tempered glass  
Vetro temperato lucido  
Verre trempé brillant

Gres

## Openings / Aperture / Ouvertures



## Door Section / Sezione Ante / Portes Sectionnelles

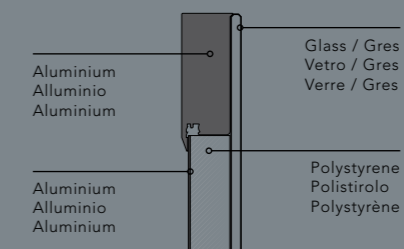

Door thickness / Spessore anta / Epaisseur de la porte 23mm

# RHO

## Finishings / Finiture / Finitions

Thermostructured melamine, concrete / sablé / eucalyptus finish  
Melaminico termostrutturato, finitura cemento / sablé / eucalipto  
Mélaminé thermostructuré, finition béton / sablé / eucalyptus

Horizontal knotted, thermostructured melamine  
Melaminico termostrutturato, nodato orizzontale  
Mélaminé thermostructuré, avec noeuds horizontal

Melamine, walnut finish  
Melaminico, finitura noce  
Mélaminé, finition noyer

Matt melamine, skin finish  
Melaminico opaco, finitura skin  
Mélaminé mat, finition skin

Maxximatt®

Maxxigloss®

## Openings / Aperture / Ouvertures

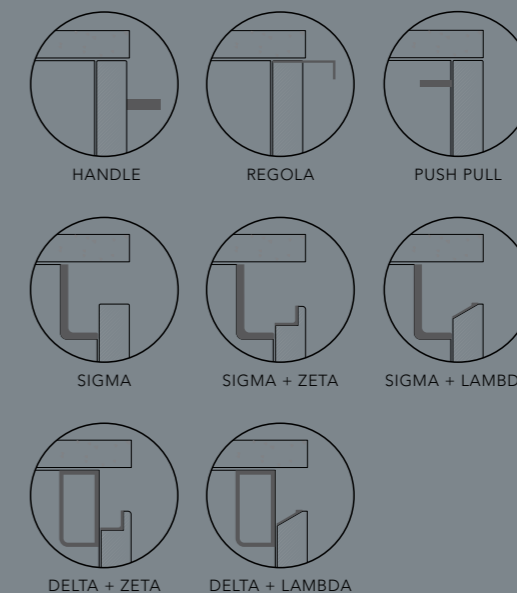

Door thickness / Spessore anta / Epaisseur de la porte 22mm



# TAU

## Finishings / Finiture / Finitions

FENIX® NTM

Matt / glossy laminated  
Laminato opaco / lucido  
Stratifié mat / brillant

Stone laminated  
Laminato pietra  
Stratifié pierre

Wood laminated  
Laminato legno  
Stratifié bois

Marble laminated  
Laminato marmo  
Marbre laminated

## Openings / Aperture / Ouvertures

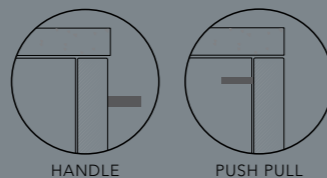

Door thickness / Spessore anta / Epaisseur de la porte 19mm

# YPSILON

## Finishings / Finiture / Finitions

Flamed thermostructured melamine  
Melaminico termostrutturato fiammato  
Mélaminé thermostructuré, flammé

Knotted thermostructured melamine  
Melaminico termostrutturato nodato  
Mélaminé thermostructuré, avec noeuds

Serrated melamine  
Melaminico seghettato  
Mélaminé tranché

Matt Laquered  
Laccato Opaco  
Laqué mat

Glossy Laquered  
Laccato Lucido  
Laqué brillant

## Openings / Aperture / Ouvertures

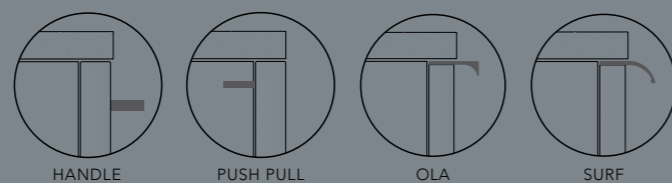

Curved elements: available for base units, wall units and tall units  
Elementi curvi: disponibili per basi, pensili e colonne  
Éléments arrondis: disponibles pour éléments bas, hauts et colonnes

Door thickness / Spessore anta / Epaisseur de la porte 19mm

# KAPPA

## Finishings / Finiture / Finitions

Glossy UV laquered  
Laccato UV Lucido  
UV brillant

Matt melamine  
Melaminico opaco  
Mélamine mat

Larch melamine  
Melaminico larice  
Mélamine mélèze

## Openings / Aperture / Ouvertures

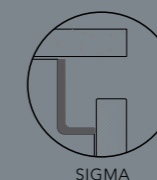
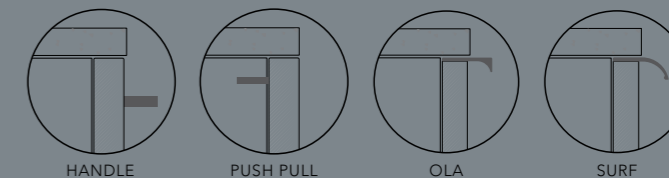

Door thickness / Spessore anta / Epaisseur de la porte 19mm

# PENTHA

## Finishings / Finiture / Finitions

Matt Laquered  
Laccato Opaco  
Laqué mat

Glossy Laquered  
Laccato Lucido  
Laqué brillant

Ecowood

## Openings / Aperture / Ouvertures



## Wall Unit / Pensile / Meuble haut



Door thickness / Spessore anta / Epaisseur de la porte 22mm

# DIADEMA

Finishings / Finiture / Finitions

Matt laquered  
Laccato opaco  
Stratifié mat

Serrated oak Naturale 2511  
Rovere seghettato Naturale 2511  
Chêne tranché Naturale 2511

Openings / Aperture / Ouvertures

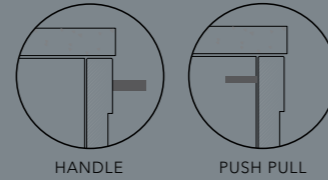

Door comprising a solid oak frame with veneered or lacquered particle board centre panel.

Anta composta da un telaio in rovere massiccio con pannello centrale in truciolare impiallacciato o laccato.

Porte composée d'un châssis en chêne rouvre massif avec panneau central de particules plaqué ou laqué.

Door thickness / Spessore anta / Epaisseur de la porte 19mm

TIPOLOGIE DI APERTURA / TYPES D'OUVERTURE

# OPENING TYPOLOGIES

# QUADRATIKA

Finishings / Finiture / Finitions

Matt oak  
Rovere opaco  
Chêne mat

Openings / Aperture / Ouvertures

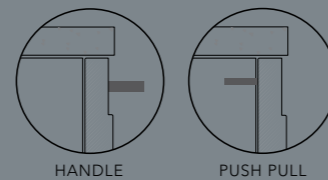

Door thickness / Spessore anta / Epaisseur de la porte 19mm



ZETA

YOTA / RHO

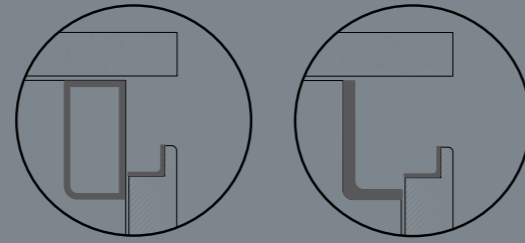

Delta groove / Sigma Groove  
Door with full-length recessed handle

Gola Delta / Gola Sigma  
Anta con maniglia incassata a tutta lunghezza

Rainure d'ouverture Delta / Sigma  
Porte avec poignée encastrée sur toute la longueur

Door thickness / Spessore anta / Epaisseur de la porte 22mm

OMICRON 22

OMICRON 22

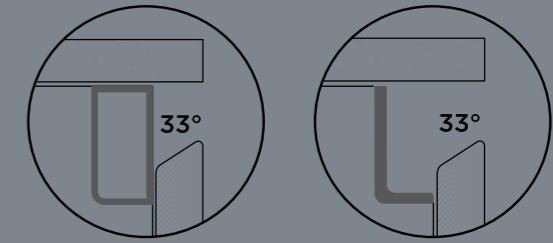

Delta groove / Sigma groove  
Door with 33° cut

Gola Delta / Gola Sigma  
Anta con taglio a 33°

Rainure Delta / Rainure Sigma  
Porte avec découpe à 33°

Door thickness / Spessore anta / Epaisseur de la porte 22mm

LAMBDA

YOTA / RHO

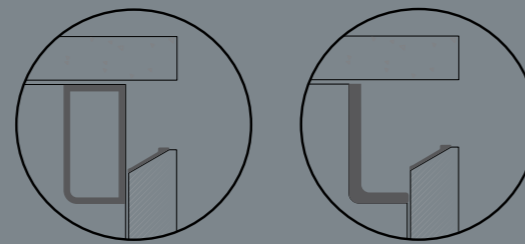
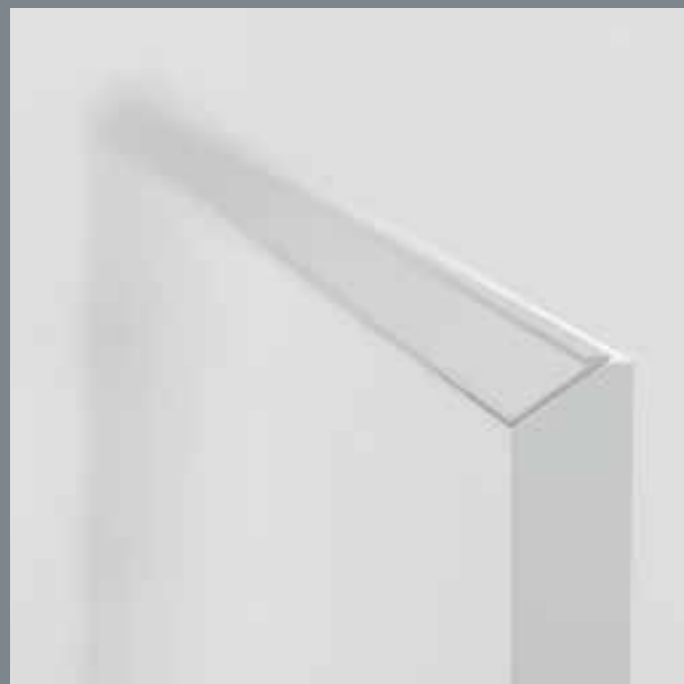

Delta groove / Sigma Groove  
Door with full-length recessed handle

Gola Delta / Gola Sigma  
Anta con maniglia incassata a tutta lunghezza

Rainure d'ouverture Delta / Sigma  
Porte avec poignée encastrée sur toute la longueur

Door thickness / Spessore anta / Epaisseur de la porte 22mm

SIGMA + DOOR WITHOUT HANDLE

YOTA / T16 / TAU  
RHO / YPSILON / KAPPA

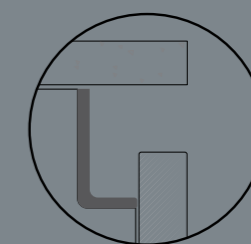

Sigma groove  
Door without handle

Gola Sigma  
Anta senza maniglia

Rainure Sigma  
Porte sans poignée

Door thickness / Spessore anta / Epaisseur de la porte 19/22mm

PENTHA

PENTHA

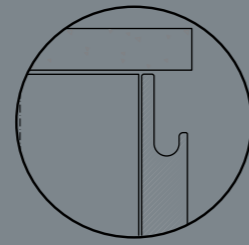
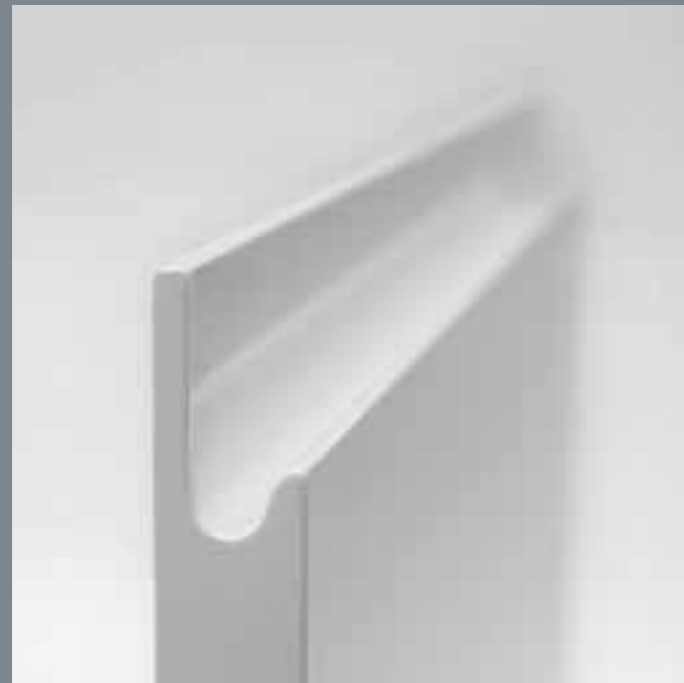

Door with handle  
Anta con presa maniglia  
Porte avec prise poignée

Door thickness / Spessore anta / Epaisseur de la porte 22mm

REGOLA

YOTA / RHO

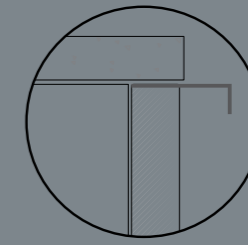

Lowered door with full-length built-in handle  
Handle finishings: Inox / Dark brown  
Anta ribassata con maniglia incassata a tutta lunghezza  
Finiture della maniglia: Inox / Testa di moro  
Porte abaissée avec poignée encastrée sur toute la longueur  
Finition de la poignée: Inox / Moka

Door thickness / Spessore anta / Epaisseur de la porte 22mm

INSIDE

YPSILON / KAPPA

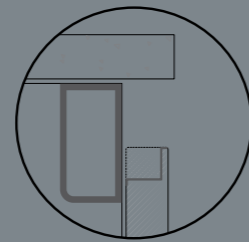

Delta groove  
Milled door with internal built-in handle  
Gola Delta  
Anta fresata con maniglia interna incassata  
Rainure Delta  
Porte fraisée avec poignée interne encastrée

Door thickness / Spessore anta / Epaisseur de la porte 19mm

OLA

YPSILON / KAPPA

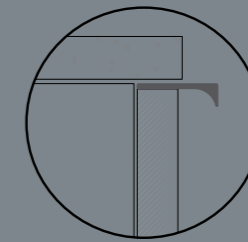

Lowered door with full-length built-in handle  
Handle finishing: inox  
Anta ribassata con maniglia incassata a tutta lunghezza  
Finitura della maniglia: Inox  
Porte abaissée avec poignée encastrée sur toute la longueur  
Finition de la poignée: Inox

Door thickness / Spessore anta / Epaisseur de la porte 19mm



**SURF**

YPSILON / KAPPA

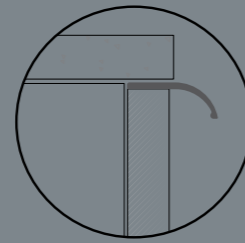

Lowered door with full-length built-in handle  
Handle finishing: Aluminium

Anta ribassata con maniglia incassata a tutta lunghezza  
Finitura della maniglia: Alluminio

Porte abaissée avec poignée encastree sur toute la longueur  
Finition de la poignée: Aluminium

Door thickness / Spessore anta / Epaisseur de la porte 19mm

ACCESSORI/ ACCESSOIRES

# ACCESSORIES

**MANIGLIA**

YOTA / TAU / RHO / YPSILON  
KAPPA / DIADEMA / QUADRATIKA

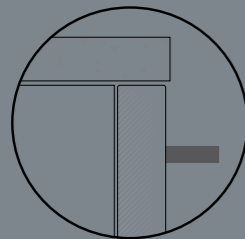

Door with handle.  
29 types of handles in the Armony collection, all available with different finishes and sizes.

Anta con maniglia.  
29 tipologie di maniglie nella collezione Armony, disponibili in varie finiture e dimensioni.

Porte avec poignée.  
29 typologies de poignées dans la collection Armony, disponibles dans différentes finitions et dimensions.

Door thickness / Spessore anta / Epaisseur de la porte 19 / 22mm

**PUSH PULL**

YOTA / TAU / RHO / YPSILON  
KAPPA / DIADEMA / QUADRATIKA

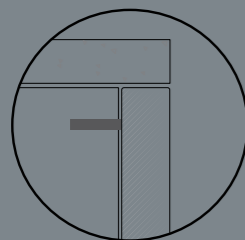

Door without handle

Anta senza maniglia

Porte sans poignée

Door thickness / Spessore anta / Epaisseur de la porte 19 / 22mm

## SIZE

Open units in skilfully assembled square section tubular aluminium, complete with bottom, back panel and, on certain units, shelves.  
Made in Nero Grafite finish anodised aluminium, they can be fitted anywhere on the wall or complete a wall unit composition with stunning effect.

Pensili a giorno in tubolari di alluminio di sezione quadrata finemente assemblati, completi di fondo, schiena e in alcuni casi di ripiani.  
Realizzati in alluminio anodizzato finitura Nero grafite, possono essere installati liberamente a parete o completare una composizione di pensili per un risultato unico.

Éléments hauts ouverts en tubes d'aluminium de section carré finement assemblés, complétés de fond, dos et dans certains cas d'étagères.  
Réalisés en aluminium anodisé Nero Grafite, ils peuvent être installés librement au mur ou compléter une composition d'éléments hauts pour un résultat unique.

## Finishings / Finiture / Finitions

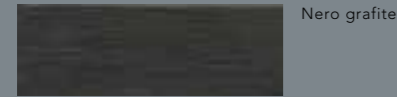

Nero grafite

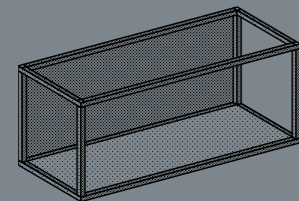

900 x 350 x H 360 mm

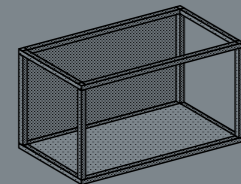

600 x 350 x H 360 mm

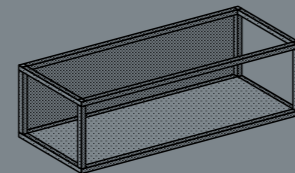

900 x 350 x H 240 mm

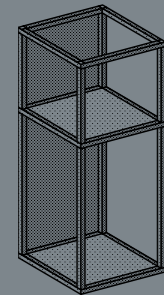

300 x 350 x H 960 mm

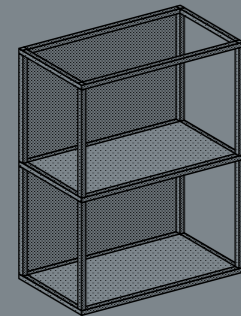

600 x 350 x H 720 mm

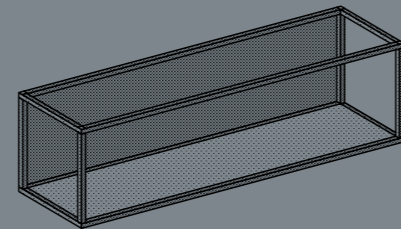

1200 x 350 x H 360 mm



## MODUS

Exclusive, free-standing storage accessories in Nero Grafite finish anodised aluminium.  
The uncluttered lines are modern and essential to provide a distinguishing element to this kitchen.

Esclusivi accessori contenitore di libera installazione in alluminio anodizzato finitura Nero grafite.  
Le linee pulite e decise gli conferiscono un design moderno ed essenziale che lo rendono un forte elemento distintivo all'interno della cucina.

Accessoires de rangement exclusifs à installation libre en aluminium anodisé finitura Nero Grafite.  
Les lignes sobres et franches leur confèrent un design moderne et essentiel qui en font un fort élément distinctif à l'intérieur de la cuisine.

## Finishings / Finiture / Finitions

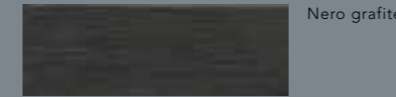

Nero grafite

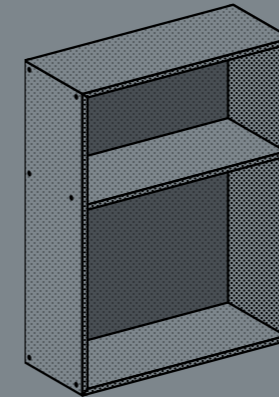

300 x 150 x H 370 mm

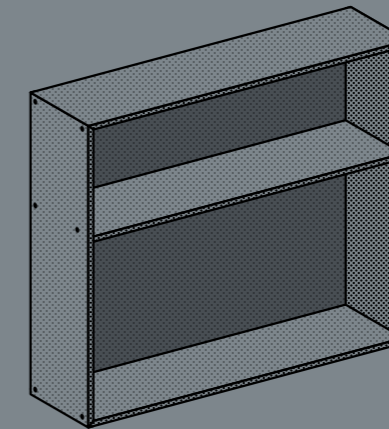

450 x 150 x H 370 mm

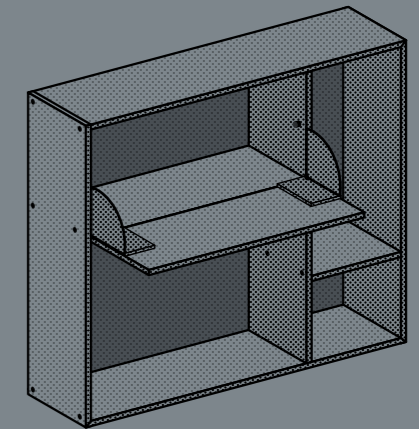

450 x 150 x H 370 mm





## MODULAR

Modular is a line of accessories designed to increase the functionality of the kitchen work area by means of a storage wall fitted with aluminium under wall unit elements provided with movable accessories.

Modular è una linea di accessori pensata per aumentare la funzionalità dell'area di lavoro della cucina, tramite una parete attrezzata di elementi sottopensile in alluminio dotati di accessori facilmente riposizionabili.

Modular est une ligne d'accessoires pensée pour augmenter la fonctionnalité de la zone de travail de la cuisine, au moyen d'une cloison équipée d'éléments sous-élément haut en aluminium dotés d'accessoires facilement repositionnables.

### Finishings / Finiture / Finitions



Titanium  
Titanio  
Titane

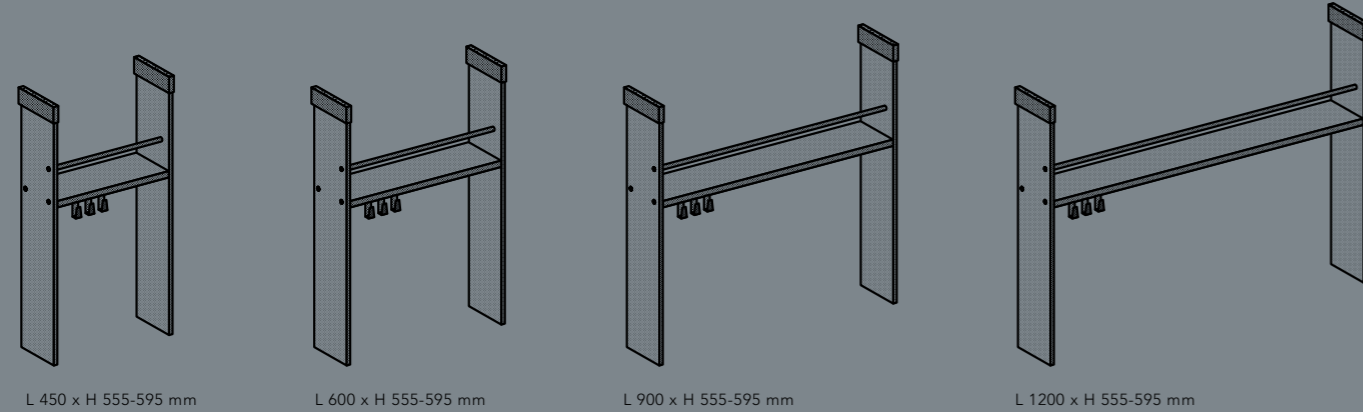

L 450 x H 555-595 mm

L 600 x H 555-595 mm

L 900 x H 555-595 mm

L 1200 x H 555-595 mm

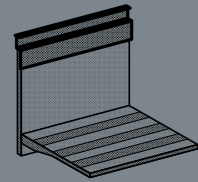

L 290 mm

Glass/aluminium shelf  
Mensola vetro/alluminio  
Tablette verre/aluminium

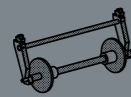

L 290 mm

Kitchen roll holder  
Porta rotolo  
Porte-rouleau



L 220 mm

Capsule holder  
Porta capsule  
Porte-capsules

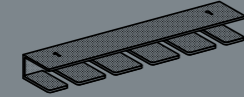

L 580 mm

Stemware holder  
Porta calici  
Porte-verres

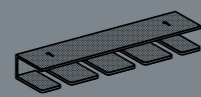

L 430 mm

Stemware holder  
Porta calici  
Porte-verres



L 140 mm

Stainless steel bin holder  
Porta contenitore inox  
Porte récipient inox



## FREEDOM

Wall profile in anodised aluminum Nero grafite, with easily replaceable accessories in aluminum finish. Its clean lines characterize the modern, minimalist design shape.

Profilo a muro in alluminio anodizzato Nero grafite dotato di accessori facilmente riposizionabili in finitura alluminio. Le sue linee pulite ne caratterizzano la forma del design moderno e minimalista.

Profil de fixation murale en aluminium anodisé finition Noir graphite avec supports pour mettre les accessoires. Ses lignes épurées caractérisent la forme du design moderne et minimaliste.

### Profile finishing / Finitura del profilo / Finition du profil

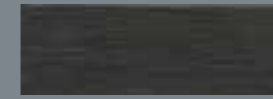

Nero grafite

### Accessories finishing / Finitura accessori / Finition accessoires



Aluminium  
Alluminio  
Aluminium

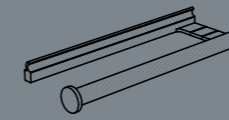

L 275 mm

Kitchen roll holder  
Porta-rotolo  
Porte-rouleau

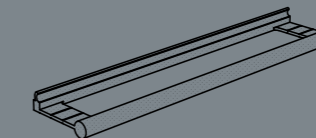

L 450 mm

Towel-rail  
Porta-asciugamano  
Porte-torchons

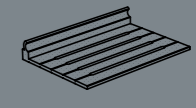

L 150 mm

Shelf with slots  
Mensola con fresate  
Etagère porte-objets avec rainures



ACCESSORI INTERNI / ACCESSOIRES INTERIEUR

---

# INTERNAL ACCESSORIES



## EASY LINE

Accessory for Antaro, Intivo and Legrabox solid wood drawers and deep baskets, available in four different finishes. Can be provided with the same finish or in stainless steel.

Accessorio per cassetto e cestone Antaro, Intivo, Legrabox in legno massello, disponibile in quattro diverse finiture. Possibilità di avere il fondo nella stessa finitura o in acciaio inox.

Accessoire pour tiroir et casserolier Antaro, Intivo, Legrabox en bois massif, disponible dans quatre finitions différentes. Possibilité d'avoir le fond dans la même finition ou en acier inox.

### Finishings / Finiture / Finitions



Beech wood  
Legno di faggio  
Bois hêtre

Black walnut wood  
Legno di noce Canaletto  
Bois noyer Canaletto

Wengè wood  
Finitura wengè  
Finition wengè

White wood  
Finitura bianca  
Finition blanc

Stainless steel  
Acciaio Inox  
Acier Inox

■ Available exclusively for the base.

Disponibile esclusivamente per il fondo.

Disponible exclusivement pour la base.



TECHNICAL DETAILS

## ELITE LINE

Accessories to equip drawers and deep baskets with the elegance of solid wood, in a choice of two finishes, coupled with stainless steel and featuring a special flared shape. Several combinations are possible and these can be enhanced further by a range of steel and propylene inserts.

Accessori per attrezzare cassetti e cestoni in modo singolare grazie al fascino del legno massello, in due finiture, accoppiato all'acciaio inox, caratterizzato da una particolare forma svasata. Diverse le combinazioni a disposizione che possono essere ulteriormente arricchite da una gamma di inserti in acciaio e polipropilene.

Accessoires pour équiper les tiroirs et les casseroliers de façon singulière grâce au charme du bois massif, dans deux finitions, assemblé à l'acier inox, caractérisé par une forme évasée particulière. Les combinaisons à disposition sont variées, elles peuvent être ensuite enrichies par une gamme d'inserts en acier et polypropylène. Elite Line est disponible pour les mécanismes Antaro, Intivo et Legrabox.

### Partition finishes / Finiture divisori / Finitions de séparation



Oak wood  
Legno di rovere  
Bois chêne

Black walnut wood  
Legno di noce Canaletto  
Bois noyer Canaletto

### Support finishes / Finiture supporto / Finitions support



Stainless steel  
Acciaio Inox  
Acier Inox



TECHNICAL DETAILS

## TECNOROCK

System of internal accessories for Antaro and Intivo mechanisms, featuring a mix of shiny steel and the warm elegance of wood. The solid wood partitions are a distinguishing feature that gives an airy elegant look to the product.

Sistema di attrezzature interne, per meccanismi Antaro e Intivo che nasce come mix tra la pulizia dell'acciaio e il calore ed eleganza del legno. Caratteristici i divisori in legno massello che conferiscono al prodotto un aspetto di leggerezza e di eleganza.

Système d'équipements internes, pour mécanismes Antaro et Intivo qui naît comme mélange entre la sobriété de l'acier et la chaleur et l'élégance du bois. Les séparations en bois massif caractéristiques confèrent au produit un aspect de légèreté et d'élégance.

### Finishings / Finiture / Finitions



Dark oak  
Rovere scuro  
Chêne foncé

Stainless steel  
Acciaio Inox  
Acier Inox



TECHNICAL DETAILS

## NOMAD

Accessories for Legrabox mechanisms, entirely in matt black painted Frassino solid wood. Nomad can be freely arranged inside drawers and deep drawers. The single elements in the system can be used to create endless combinations to meet all tastes and needs.

Accessori per meccanismi Legrabox interamente realizzati in legno massello di Frassino verniciato nero opaco. Nomad offre la massima libertà di allestimento interno di cassetti e cestoni. Grazie infatti agli elementi singoli che compongono il programma è possibile creare infinite combinazioni, in base al gusto e alle esigenze.

Accessoires pour mécanismes Legrabox entièrement réalisés en bois massif de Frêne verni noir mat. Nomad offre une liberté maximum d'aménagement interne des tiroirs et casseroles. En effet, grâce aux éléments simples qui composent le programme, il est possible de créer des combinaisons infinies, selon le goût et les exigences.

### Finishings / Finiture / Finitions



Dark Ashwood  
Frassino scuro  
Frêne foncé



TECHNICAL DETAILS



## EVOLUTION

One of the lines of deep drawer waste bins for deep baskets included in the Armony range of accessories for the separate collection of waste. Featuring Evolution stainless steel lids with controlled release air fresheners.

Una delle linee di pattumiere per cestone offerte dal programma accessori Armony per la raccolta differenziata dei rifiuti. Caratterizzate dai coperchi Evolution in acciaio inox con profumatore a dosaggio controllato.

Une des lignes de poubelles pour casseroles offertes par le programme accessoires Armony pour le tri sélectif des déchets. Caractérisées par les couvercles Evolution en acier inox avec parfumeur à dosage contrôlé.

### Finishings / Finiture / Finitions

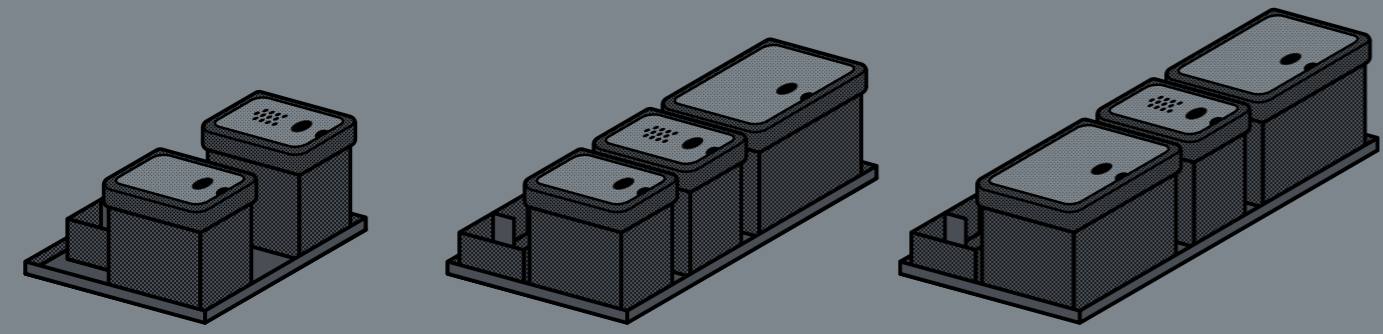
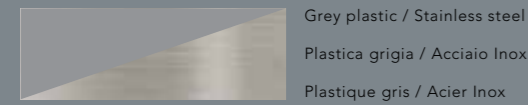

L 600 mm

L 900 mm

L 1200 mm

18+8 litre buckets, sponge/detergent holder  
N. 2 secchi 18+8 litri, portaspugne/detersivi  
N. 2 seaux 18+8 litres, porte-éponges/produits d'entretien

17.5+8+8 litre buckets, sponge/detergent holder  
N. 3 secchi 17,5+8+8 litri, portaspugne/detersivi  
N. 3 seaux 17,5+8+8 litres, porte-éponges/produits d'entretien

17.5+17.5+8 litre buckets, sponge/detergent holder  
N. 3 secchi 17,5+17,5+8 litri, portaspugne/detersivi  
N. 3 seaux 17,5+17,5+8 litres, porte-éponges/produits d'entretien



## PREMIERE

Line of deep drawer waste bins for separate waste collection, complete with buckets, sponge/detergent holders and magazine rack. The distinguishing features are designer good looks.

Linea di pattumiere per cestone per la raccolta differenziata dei rifiuti, completa di secchi, porta spugne/detersivi e porta riviste. Si distingue per una forte connotazione estetica e di design.

Ligne de poubelles pour casseroles pour le tri sélectif des déchets, complété de seaux, porte-éponges/produits d'entretien et porte revues. Elle se distingue par une forte connotation esthétique et de design.

### Finishings / Finiture / Finitions

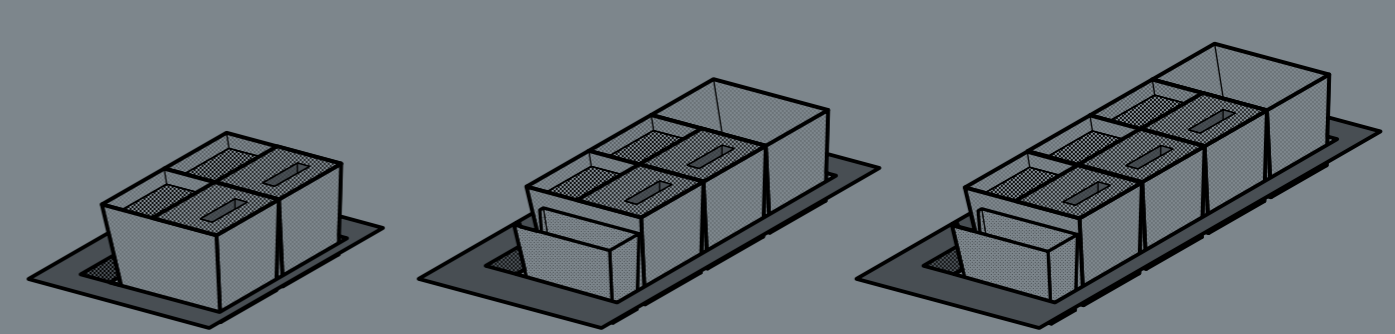

L 600 mm

L 900 mm

L 1200 mm

2 x 13+13 litre buckets, sponge/detergent holder  
2 secchi 13+13 litri, portaspugne/detersivi  
2 seaux 13+13 litres, porte-éponges/produits d'entretien

3 x 13x3 litre buckets, sponge/detergent holder and magazine rack.  
3 secchi 13x3 litri, portaspugne/detersivi, portariviste  
3 seaux 13x3 litres, porte-éponges/produits d'entretien

4 x 13x4 litre buckets, sponge/detergent holder and magazine rack.  
4 secchi 13x4 litri, portaspugne/detersivi, portariviste  
4 seaux 13x4 litres, porte-éponges/produits d'entretien



## SOLUTIONS FOR CORNERS

The modules in the vast Armony collection also provide several solutions with which to make the most of kitchen corners. Below, the top quality Italian or German mechanisms, all with the same aim of making the most of the space available.

Nei moduli presenti nella vasta collezione Armony troviamo anche diverse soluzioni per sfruttare al meglio gli angoli nelle cucine che li prevedono. Qui sotto i meccanismi, tutti italiani o tedeschi per offrire la massima qualità, uguali nello scopo di usufruire di tutto lo spazio a disposizione.

Dans les modules présents dans la vaste collection armony, nous trouvons également différentes solutions pour exploiter au mieux les angles dans les cuisines qui les prévoient. Ci-dessous, les mécanismes, tous italiens ou allemands pour offrir une qualité maximum, identiques dans le but d'utiliser tout l'espace à disposition.

### Mondo

The MONDO base unit with 360° revolving baskets designed for 90 x 90 corner base units is completed by plastic slip-resistant shelves. The main features of this mechanism are the total exploitation of the storage capacity of a corner that is not usually suitable for this and, last but not least, the possibility of seeing the entire contents without having to bend down to reach the objects.

La base MONDO con cesti rotanti a 360°, prevista su basi angolo 90 x 90, è completata con ripiani in plastica dotati di antiscivolo. Caratteristiche primarie di questo meccanismo sono il totale sfruttamento della capienza di un angolo che normalmente non si presta a tale scopo e, non ultima, la possibilità di avere sott'occhio tutto il contenuto senza doversi scomodamente chinare per raggiungere gli oggetti.

Le meuble bas MONDO avec paniers tourniquets à 360°, prévu dans des meubles bas d'angle de 90 x 90, a également des étagères en plastique antidérapant. Les caractéristiques primaires de ce mécanisme sont l'exploitation complète d'un angle qui, normalement, n'est pas prévu pour le rangement et de plus, la possibilité d'avoir sous les yeux tout le contenu du meuble sans besoin de se plier pour atteindre les objets.

### Le Mans

An alternative to the corner base unit pullout baskets consists in shelves with a white, anti-slip surface and a chromed rail along the perimeter that come completely out of the carcass, making them practical to use and offering a remarkable capacity. The corner base units have 2 shelves while the corner tall units have 4. Each shelf has a capacity of 20 kg and has been tested for 40,000 opening/closing cycles.

Un'alternativa ai cestelli a traino per base angolo: costituito da ripiani con fondo antiscivolo bianco e una ringhiera perimetrale cromata che escono completamente dalla scocca, offrendo praticità d'utilizzo e una notevole capacità di carico.

Le basi ad angolo sono previste con 2 ripiani, mentre le colonne ad angolo ne prevedono 4. Ogni ripiano ha una portata di 20 kg ed è stato testato per 40.000 cicli di apertura/chiusura.

Il est conçu comme alternative aux paniers à traction pour les meubles d'angle. Il est formé de plateaux avec un fond antidérapant blanc entourés d'une barrière chromée sur tout le pourtour, qui sortent complètement du caisson, en offrant une grande commodité d'utilisation et une remarquable capacité de chargement. Les meubles bas d'angle sont dotés de deux plateaux, tandis que les colonnes d'angle en comptent quatre. Chaque plateau a une charge utile de 20 kg et a été testé pour 40 000 cycles d'ouverture/fermeture.

### Magic Corner

An ergonomic solution for corner base units; when the door is opened, it moves to the side simplifying access to the baskets that slide inside the carcass. The mechanism has a maximum capacity of 35 kg and has been tested for 55,000 opening/closing cycles. The corner base units have 4 baskets while the corner tall units are provided with 8. The baskets are available in 2 versions:

- baskets completely in chromed wire
- "ARENA STYLE" baskets by Kesseböhmer with a white, anti-slip bottom.

Una soluzione ergonomica per le basi ad angolo; aprendo l'anta, questa si sposta da un lato facilitando l'accesso ai cesti che scorrono all'interno della scocca. Il meccanismo ha una portata massima di 35 kg ed è stato collaudato per 55.000 cicli di apertura/chiusura. Le basi ad angolo sono previste con 4 cesti, mentre le colonne ad angolo ne prevedono 8. I cesti sono disponibili in 2 versioni:

- cesti completamente in filo cromato
- cesti "ARENA STYLE" by Kessebohmer con fondo piatto bianco antiscivolo.

Une solution ergonomique pour les meubles d'angle: en ouvrant la porte, celle-ci se déplace sur le côté, ce qui permet l'accès aux paniers qui sortent de l'intérieur du caisson. Le mécanisme a une charge utile maximale de 35 kg et a été testé pour 55 000 cycles d'ouverture/fermeture. Les meubles bas d'angles sont prévus avec quatre paniers. Les paniers sont disponibles en deux versions:

- paniers tout fil chromé
- paniers ARENA STYLE de Kesseböhmer avec un fond plein blanc antidérapant.



TECHNICAL DETAILS

## TALL UNITS WITH ACCESSOIRES

The tall storage units in the Armony collection come with German Kesseböhmer mechanisms tested to last a lifetime. They provide the advantage of using all the internal space of the unit conveniently and rapidly in an ergonomic kitchen.

Le colonne attrezzate della collezione Armony sono dotate di meccanismi tedeschi Kesseböhmer testati per durare nel tempo. Offrono il vantaggio di usufruire di tutto lo spazio interno del mobile in modo comodo e veloce per una cucina che rispetti i migliori criteri di ergonomia.

Les colonnes équipées de la collection armony sont dotées de mécanismes allemands Kesseböhmer testés pour durer dans le temps. Ils offrent l'avantage d'utiliser tout l'espace interne du meuble de façon commode et rapide pour une cuisine qui respecte les meilleurs critères d'ergonomie.

### Tall units with "CONVOI" pull-out doors Colonne estraibili "CONVOI" Colonnes coulissantes "CONVOI"

Pull-out tall unit with Kesseböhmer "Convoi" mechanism, fitted with 5 height adjustable baskets that can be pulled out with one finger. The white bottom is non-slip and the sides are in glass.

La colonna estraibile con meccanismo "Convoi" Kesseböhmer è equipaggiata di 5 cesti estraibili con un solo gesto e regolabili in altezza. Il fondo è antiscivolo bianco e le spondine in vetro.

la colonne amovible avec mécanisme "Convoi" Kesseböhmer est équipée de 5 paniers amovibles avec un seul geste et réglables en hauteur. Le fond est antiglisse et les bords en verre.

### Tall units with accessoires Colonne attrezzate Colonnes équipées

Tall units provided with "arena style" baskets by Kesseböhmer applied either inside the unit or on the door. During opening the mechanism moves towards the user so that everything is to hand. Approved for 30,000 opening/closing cycles, maximum capacity 50 kg.

Sono colonne dotate di cestelli "Arena style" by Kesseböhmer applicati sia all'interno del mobile che sull'anta. Durante l'apertura il meccanismo si sposta verso l'utilizzatore per avere tutto a portata di mano. Sono collaudate per 30.000 cicli di apertura/chiusura ed una portata massima utile di 50 kg.

Ce sont des colonnes dotées de paniers "arena style" by Kesseböhmer appliqués aussi bien à l'intérieur du meuble que sur la porte. Pendant l'ouverture, le mécanisme se déplace vers l'utilisateur pour tout avoir à portée de main. Elles sont testées pour 30.000 cycles d'ouverture/fermeture et ont une portée maximum utile de 50 kg.

### Tall units with pull-out doors Colonne estraibili Colonnes avec structure extractible

Tall units and full extension structures with height adjustable baskets, also with a pull-out, revolving version. Two types of baskets are available:

- entirely in chrome-plated wire
- "arena style" baskets by Kesseböhmer with white, non-slip flat bottom.

Tall units are approved for 30,000 opening/closing cycles and have a maximum capacity of 50 kg.

Colonne a struttura estraibile totale con cestelli regolabili in altezza, anche nella versione estraibile e girevole. Sono disponibili 2 tipi di cestelli:

- completamente in filo cromato
- cesti "Arena Style" by Kesseböhmer con fondo piatto bianco antiscivolo.

Le colonne sono collaudate per 30.000 cicli di apertura/chiusura ed hanno una portata massima utile di 50 kg.

Colonnes à structure amovible totale avec paniers réglables en hauteur, également dans la version amovible et tournante. 2 types de paniers sont disponibles :

- complètement en fil chromé
- paniers "arena style" by Kesseböhmer avec fond plat blanc antiglisse.

Les colonnes sont testées pour 30.000 cycles d'ouverture/fermeture et ont une portée maximum utile de 50 kg.



TECHNICAL DETAILS



## WING

Wing is a mechanism used on tall units with recessed doors. These can be equipped with household appliances, different accessories and a stainless steel pull-out top. The advantage of this type of equipped tall unit is that it can be entirely closed up, maintaining the clean, modern lines of the composition.

Wing è un meccanismo che permette di realizzare colonne con ante rientranti. Queste possono essere attrezzate con elettrodomestici, diversi accessori e un piano estraibile in acciaio inox. Il vantaggio di questa tipologia di colonna attrezzata è la possibilità di richiuderla completamente per mantenere la composizione pulita e moderna.

Wing est un mécanisme qui permet de réaliser des colonnes avec portes rentrantes. Elles peuvent être équipées avec des appareils électroménagers, différents accessoires et un plan amovible en acier inox. L'avantage de cette typologie de colonne équipée est la possibilité de la refermer complètement pour maintenir la composition sobre et moderne.



TECHNICAL DETAILS

The Wing mechanism allows the doors to rotate 90° and be pushed into the carcass of the tall units. A sophisticated German mechanism that provides an optimal and flexible use of the space, without being hindered by the doors.

Il meccanismo Wing consente alle porte di ruotare di 90° e di essere spinte all'interno della scocca del mobile colonna. Un sofisticato meccanismo tedesco che fornisce un ottimale e flessibile uso dello spazio, senza essere ostacolati da sporgenti porte.

Le mécanisme Wing permet aux portes de tourner de 90° et être poussées à l'intérieur du caisson de l'armoire. Un mécanisme allemand sophistiqué qui offre une utilisation optimale et flexible de l'espace, sans être gêné par des portes débordantes.

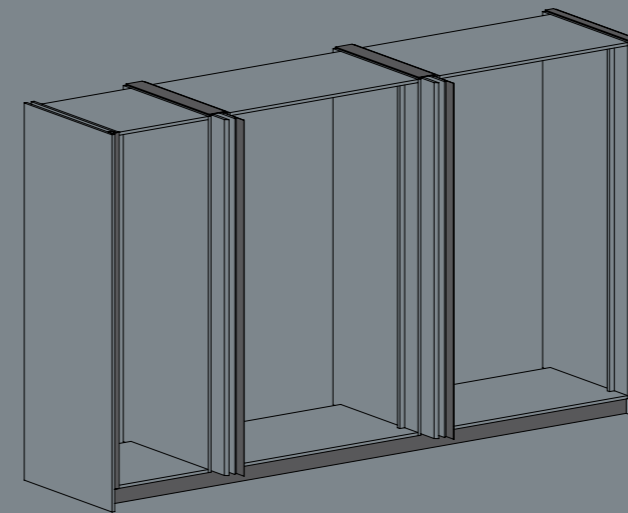

Example of the Wing mechanism open.

Esempio del meccanismo Wing aperto.

Exemple du mécanisme Wing ouvert.

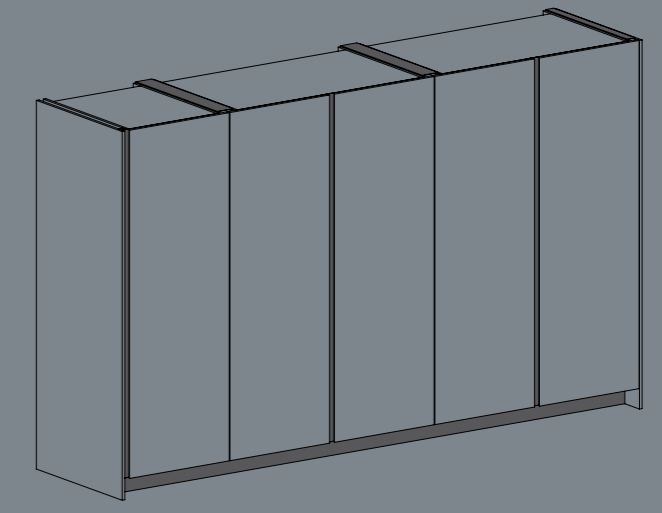

Example of the Wing mechanism close.

Esempio del meccanismo Wing chiuso.

Exemple du mécanisme Wing fermé.

## Example of modularity / Esempio di modularità / Exemple de modularité

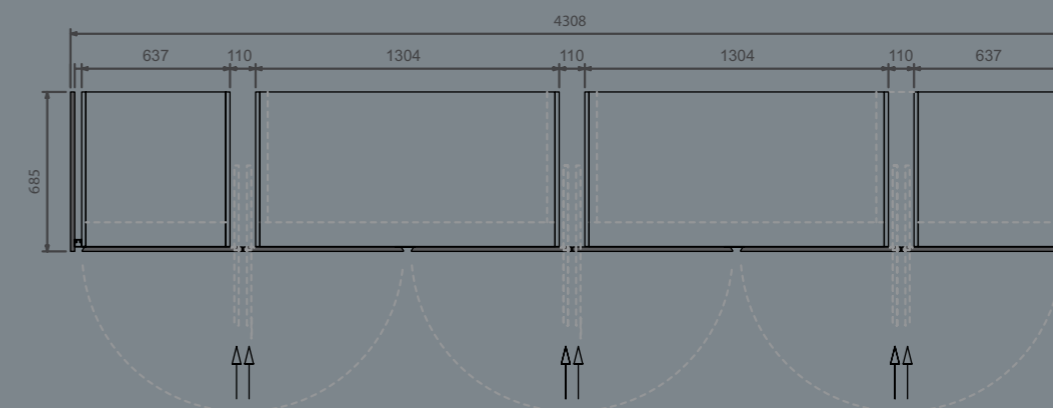

TECHNICAL DETAILS

## CERTIFICATIONS

Manufacturing means giving a firm undertaking to those who will live in our kitchens, because the first ingredient of ARMONY kitchens is trust. This is why we have certified all our organisational processes according to the international standard UNI EN ISO 9001 and given our customers the opportunity to have a FSC® certified kitchen, i.e. a kitchen where all the wood components come from forests where strict environmental, social and economic standards are applied showing respect for both current and future generations.

Armony was also the first Italian company of kitchen-manufacturers to take an interest in gaining the GREENGUARD trademark that uses the most rigorous scientific criteria to certify standards that help reduce indoor air pollution and the risk of exposure to chemicals, and help create healthier indoor environments.

Produrre significa prendersi un impegno preciso con chi abiterà le nostre cucine, perché il primo ingrediente di una cucina ARMONY è la fiducia. Per questo abbiamo certificato tutti i nostri processi organizzativi secondo la norma internazionale UNI EN ISO 9001 e dato la possibilità ai nostri clienti di avere una cucina certificata FSC®, cioè una cucina in cui tutti i componenti di legno provengono da foreste dove sono applicati rigorosi standard ambientali, sociali ed economici nel rispetto delle generazioni attuali e future.

Armony è inoltre la prima azienda italiana di cucine ad essersi interessata e ad ottenere il marchio GREENGUARD che certifica, con i più rigorosi criteri scientifici, standard che aiutano a ridurre l'inquinamento dell'aria interna ed il rischio di esposizione chimica aiutando la creazione di ambienti interni più sani.

Produire signifie s'engager sérieusement avec les personnes qui habiteront dans nos cuisines car la confiance est le premier ingrédient d'une cuisine ARMONY. Pour cela, nous avons certifié l'ensemble de nos processus organisationnels selon la norme internationale UNI EN ISO 9001 et, donné la possibilité à nos clients d'avoir une cuisine certifiée FSC®, c'est-à-dire une cuisine où tous les composants en bois proviennent de forêts où sont appliquées des normes rigoureuses environnementales, sociales et économiques à l'égard des générations actuelles et futures.

Armony est également la première entreprise italienne de cuisines à s'être intéressée et à avoir obtenu la marque GREENGUARD qui certifie, avec les critères scientifiques les plus rigoureux, des normes qui aident à réduire la pollution de l'air intérieur et le risque d'exposition chimique, en aidant à créer des environnements intérieurs plus sains.



Our Quality Management System complies with UNI EN ISO 9001



The mark of responsible forestry

Ask for FSC® certified products



Ask for Greenguard certified products



CATAS Institute for research on wood



#### CREDITS

PRINT / STAMPA / IMPRIME  
Grafiche Antiga (TV)

COLOUR SEPARATION / FOTOLITO / SEPARATION DES COULEURS  
Image vr (VR)

GRAPHIC DESIGN / GRAFICA / GRAPHIQUE  
Studio Anice (MI)

Printed in Italy  
Stampato in Italia  
Imprimé en Italie

Armony may introduce without notice any technical and structural changes on the product. Any color differences may be due to the printing process.

Armony si riserva di introdurre senza preavviso eventuali modifiche tecnico-costruttive sul prodotto. Eventuali differenze di colore possono essere dovute al processo di stampa.

Armony se réserve d'introduire sans préavis des modifications techniques-constructives sur le produit. Des éventuelles différences de teinte peuvent être dû au processus d'impression.

# ARMONY

Armony S.P.A.  
Via Tremeacque, 26  
31040 Mansuè (TV)  
Tel. +39.0422.711311  
Fax Italia +39.0422.711321  
Fax Export +39.0422.711323  
armony@armonycucine.it

[www.armonycucine.it](http://www.armonycucine.it)



